

The right way to attach almost anything to metal roofs!

S-5![®]

The Right Way!

S-5-T Clamp

The S-5-T clamp is specially developed to fit profiles having a "T" shaped seam configuration. It will also work on architectural "single-fold," or "horizontal seam" profiles having a horizontal projection of 5/8" or less. Its two-piece design allows it to be easily installed anywhere along the length of the panel seam.

The S-5-T is perfect for use with S-5![®] ColorGard[®] snow retention system and other heavy-duty applications.

Installation is as simple as placing the clamp on the seam, positioning the insert piece, and tightening the patented round-point setscrews to the specified tension. Then, affix ancillary items using the bolt provided. Go to www.S-5.com/tools for information and tools available for properly attaching and tensioning S-5! clamps.

S-5-T Mini Clamp

The S-5-T Mini is a bit shorter than the S-5-T and has one setscrew rather than two. The Mini is the choice for attaching all kinds of rooftop accessories: signs, walkways, satellite dishes, antennas, rooftop lighting, lightning protection systems, solar arrays, exhaust stack bracing, conduit, condensate lines, mechanical equipment—just about anything!*

*S-5! Mini clamps can be used with RamGard[®] unitized snow guards, but are not compatible and should not be used with S-5! SnoRail[™]/SnoFence[™] or ColorGard[®] snow retention systems.

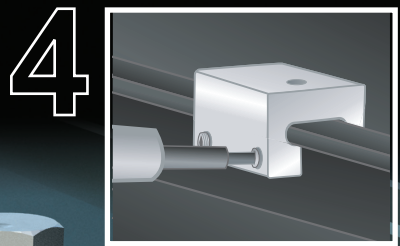
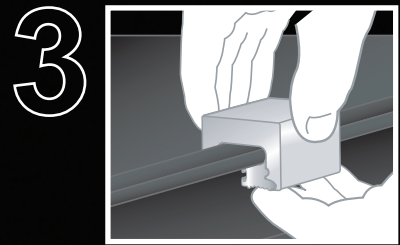
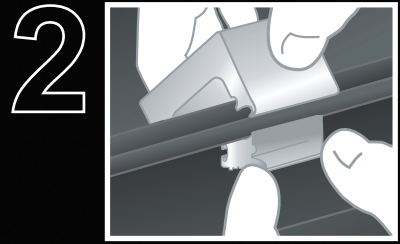
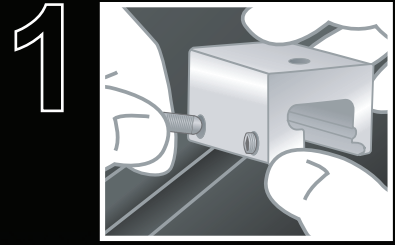

The S-5-T clamp is specifically developed to fit profiles having a "T" shaped seam configuration.

S-5-T and S-5-T Mini

888-825-3432 | www.S-5.com

S-5![®]

The Right Way!

The strength of the S-5-T clamp is in its simple design. The patented setscrews will slightly dimple the metal seam material but will not puncture it—leaving roof warranties intact.

The **S-5-T** and **S-5-T Mini clamps** are each furnished with the hardware shown to the right. Each box also includes a bit tip for tightening setscrews using an electric screw gun. A structural aluminum attachment clamp, the S-5-T is compatible with most common metal roofing materials excluding copper. All included hardware is stainless steel. Please visit www.S-5.com for more information including CAD details, metallurgical compatibilities and specifications.

The S-5-T clamp has been tested for load-to-failure results on a variety of "T" shaped standing seam roof profiles from leading manufacturers of panels. The independent lab test reports found on our website at www.S-5.com prove that S-5![®] holding strength is unmatched in the industry.

Example Profiles

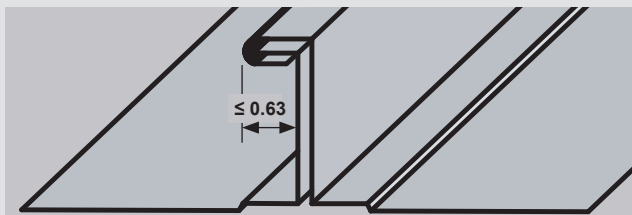
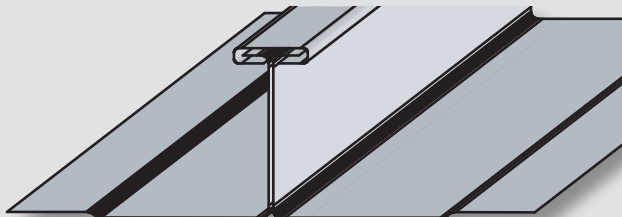

S-5-T Clamp

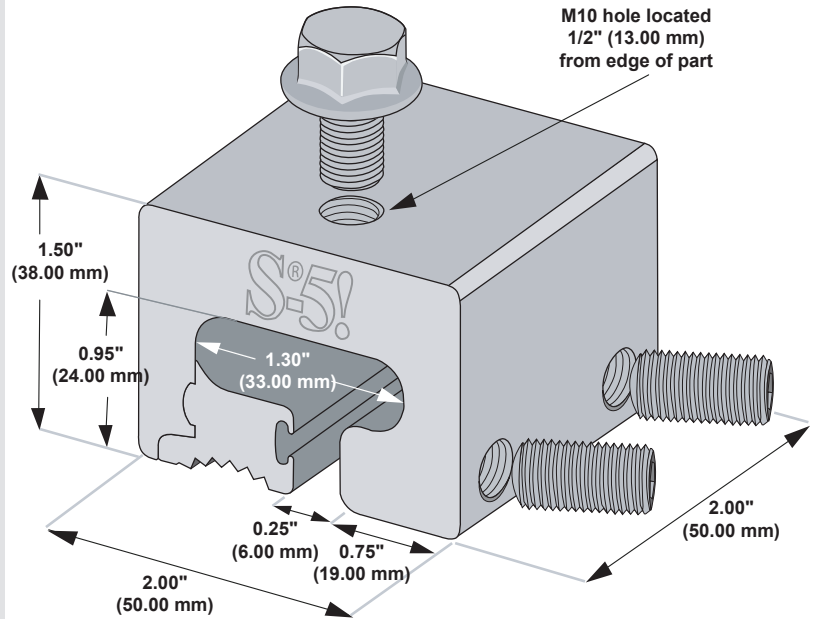

S-5-T Mini Clamp

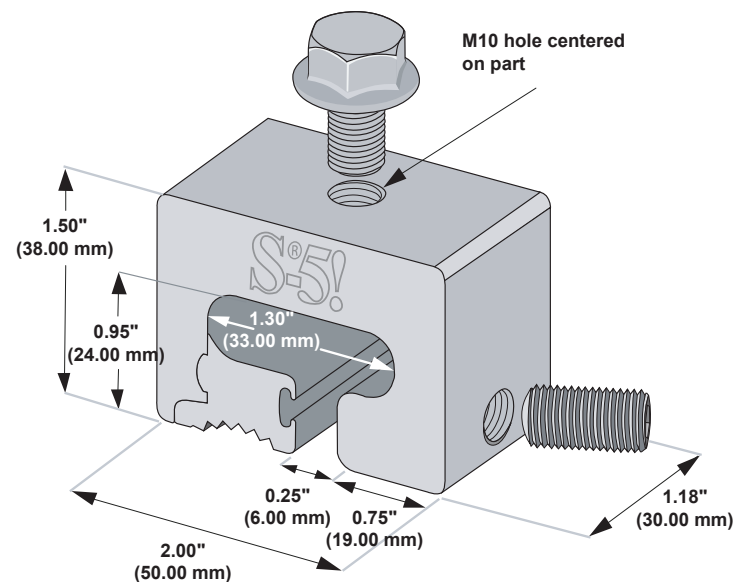

Please note: All measurements are rounded to the second decimal place.

S-5![®] Warning! Please use this product responsibly!

Products are protected by multiple U.S. and foreign patents. Visit the website at www.S-5.com for complete information on patents and trademarks. For maximum holding strength, setscrews should be tensioned and re-tensioned as the seam material compresses. Clamp setscrew tension should be verified using a calibrated torque wrench between 160 and 180 inch pounds when used on 22ga steel, and between 130 and 150 inch pounds for all other metals and thinner gauges of steel. Consult the S-5! website at www.S-5.com for published data regarding holding strength.

Copyright 2012, Metal Roof Innovations, Ltd. S-5! products are patented protected. S-5! aggressively protects its patents, trademarks and copyrights.

Distributed by