

Test Report

For

ANSI/CAN/UL9540A

Test Method for Evaluating Thermal Runaway Fire Propagation in Battery Energy Storage Systems

[Unit Level]

Report Number: CQES220800015301

Date of issue: 2022-09-07

Total number of pages: 40

Test object / Model: Lithium Ion Battery R-Bracket

Applicant's name: Shanghai PYTES Energy CO., Ltd.

Address: No. 3492 Guangming Jinqian Road, Qingcun Town, Fengxian District, Shanghai, China



Unless otherwise agreed in writing, this document is issued by the Company subject to its General Conditions of Service printed overleaf, available on request or accessible at <https://www.sgs.com/en/Terms-and-Conditions>. Attention is drawn to the limitation of liability, indemnification and jurisdiction issues defined therein. Any holder of this document is advised that information contained hereon reflects the Company's findings at the time of its intervention only and within the limits of Client's instructions, if any. The Company's sole responsibility is to its Client and this document does not exonerate parties to a transaction from exercising all their rights and obligations under the transaction documents. This document cannot be reproduced except in full, without prior written approval of the Company. Any unauthorized alteration, forgery or falsification of the content or appearance of this document is unlawful and offenders may be prosecuted to the fullest extent of the law. Unless otherwise stated the results shown in this test report refer only to the sample(s) tested and such sample(s) are retained for 30 days only.

Attention: To check the authenticity of testing/inspection report & certificate, please contact us at telephone: (86-755) 6307 1443, or email: CN.Doccheck@sgs.com

SGS-CEC (Chongqing) Technology (Chongqing) Co., Ltd. Affiliates No.8, No.2 Fuyun Road, Shuanglu Street, Jiangjin District, Chongqing, China (No.1 Laboratory Building, Chongqing Energy College) 402260 t (86-23) 863676001 www.sgs.com.cn
 中国·重庆市江津区双福街道福云大道2号附6号(重庆能源职业学院1#实验楼幢) 邮编: 402260 t (86-23) 863676001 sgs.china@sgs.com

Report Number: CQES220800015301
Manufacturer: Shanghai PYTES Energy CO., Ltd.
Address: No. 3492 Guangming Jinqian Road, Qingcun Town, Fengxian District, Shanghai, China
Factory: Shanghai PYTES Energy CO., Ltd.
Address: No. 3492 Guangming Jinqian Road, Qingcun Town, Fengxian District, Shanghai, China
Test object / Model: Lithium Ion Battery
R-Bracket
Test specifications: ANSI/CAN/UL9540A:2019 Test Method for Evaluating Thermal Runaway Fire Propagation in Battery Energy Storage Systems Fourth Edition, Dated November 12, 2019
Date of receipt: 2022-07-18
Sample No.: Customer ID
Test Period: 2022-07-18 to 2022-08-15
Issuing Laboratory: SGS-CEC New Energy Technology (Chongqing) Co., Ltd.
Address: Affiliate No. 6, No. 2 Fuyun Road, Shuangfu Street, Jiangjin District, Chongqing, China (No.1 Laboratory Building, Chongqing Energy College)
SGS-CEC New Energy Technology (Chongqing) Co., Ltd.
Testing location: Affiliate No. 6, No. 2 Fuyun Road, Shuangfu Street, Jiangjin District, Chongqing, China (No.1 Laboratory Building, Chongqing Energy College)
Test Result: Refer to summary of test results page for details.
Remark: Test results reported relate only to the items being tested.

Tested by / Witness by

Reviewed by

Ryan Hu
Project Engineer

Jerry Xiao
Technical Manager



Unless otherwise agreed in writing, this document is issued by the Company subject to its General Conditions of Service printed overleaf, available on request or accessible at <https://www.sgs.com/en/terms-and-conditions>. Attention is drawn to the limitation of liability, indemnification and jurisdiction issues defined therein. Any holder of this document is advised that information contained hereon reflects the Company's findings at the time of its intervention only and within the limits of Client's instructions, if any. The Company's sole responsibility is to its Client and this document does not exonerate parties to a transaction from exercising all their rights and obligations under the transaction documents. This document cannot be reproduced except in full, without prior written approval of the Company. Any unauthorized alteration, forgery or falsification of the content or appearance of this document is unlawful and offenders may be prosecuted to the fullest extent of the law. Unless otherwise stated the results shown in this test report refer only to the sample(s) tested and such sample(s) are retained for 30 days only.

Attention: To check the authenticity of testing / inspection report & certificate, please contact us at telephone: (86-755) 8307 1443, or email: CN.Doccheck@sgs.com

SGS-CEC New Energy Technology (Chongqing) Co., Ltd. | Affiliate No.6, No.2 Fuyun Road, Shuangfu Street, Jiangjin District, Chongqing, China (No.1 Laboratory Building, Chongqing Energy College) 402260 | t (86-23) 863676001 | www.sgs.com.cn
 中国·重庆市江津区双福街道福云大道2号附6号 (重庆能源职业学院1#实验楼) | 邮编: 402260 | t (86-23) 863676001 | sgs.china@sgs.com

[Summary of Test results]

Cell Level Test
Cell model:
CB27173204EA
Project No:
CN21GRDU 001

Cell Design:	CB27173204EA
Thermal Runaway Methodology:	External heating
Cell Surface Temperature at Gas venting:	209.4°C
Cell Surface Temperature at the onset Thermal Runaway:	270.7°C
Gas Composition:	Hydrocarbon, H ₂ , CO ₂ , CO
Lower Flammability Limit:	5.6 Vol% at ambient temperature 4.5 Vol% at 200°C
Burning Velocity:	83.6 cm/s
Pmax:	1.015 MPa
Thermal Runaway was Induced in the Cell or not:	Induced
Cell Vent Gas is Flammable or not in Air:	Flammable

Unit Level Test
Model: R-Bracket
Report No:
CQES220800015301

Unit Design:	R-Bracket
Thermal Runaway Methodology:	External heating
External Flaming:	No external flaming observed
Locations of Flame Extension:	No flame extension observed
Flying Debris:	No flying debris observed
Explosion or not:	No explosion observed
Max. Surface Temperature of Module in Target BESS Unit:	158.1°C
Max. Temperature Rise on Wall Surfaces:	94.3°C
Thermal Runaway are Contained by the Unit Design or not:	Contained by the unit design
Cell Vent Gas is Flammable or not:	Flammable
Cheesecloth Indicator Flaming or not:	No flaming or carbonizing of the cheesecloth indicator
Test Video File:	Archived by applicant

Remark: This report only evaluated unit level test which is listed inside the dotted box.



Unless otherwise agreed in writing, this document is issued by the Company subject to its General Conditions of Service printed overleaf, available on request or accessible at <https://www.sgs.com/en/Terms-and-Conditions>. Attention is drawn to the limitation of liability, indemnification and jurisdiction issues defined therein. Any holder of this document is advised that information contained hereon reflects the Company's findings at the time of its intervention only and within the limits of Client's instructions, if any. The Company's sole responsibility is to its Client and this document does not exonerate parties to a transaction from exercising all their rights and obligations under the transaction documents. This document cannot be reproduced except in full, without prior written approval of the Company. Any unauthorized alteration, forgery or falsification of the content or appearance of this document is unlawful and offenders may be prosecuted to the fullest extent of the law. Unless otherwise stated the results shown in this test report refer only to the sample(s) tested and such sample(s) are retained for 30 days only.

Attention: To check the authenticity of testing / inspection report & certificate, please contact us at telephone: (86-755) 8307 1443, or email: CN.Doccheck@sgs.com

Affiliate No.5, No.2 Fuyun Road, Shuangliu Street, Jiating District, Chongqing, China (No.1 Laboratory Building, Chongqing Energy College) 402260 | (86-23) 863676001 | www.sgsgroup.com.cn
 中国·重庆市江津区双福街道福云大道2号附6号(重庆能源职业学院1#实验楼幢) 邮编: 402280 | (86-23) 863676001 | sgs.china@sgs.com

[Test object Description]

Table 1: Description of component cell

Model:	[REDACTED]	
Manufacturer:	[REDACTED]	
Nominal capacity:	100 Ah	
Nominal voltage:	3.2 V	
Chemistry:	Lithium ion, LiFePO4	
Charge current:	100 A	
Charge current:	100 A	
Maximum charge voltage:	3.65 V	
Cut-off Voltage:	2.5 V	
External dimensions:	207.01±0.6mm *174.7mm±0.6mm * 27.5mm±1.0mm	
UL 1973 compliant:	<input type="checkbox"/> Yes / <input type="checkbox"/> No	N/A
UL 9540A report provided:	<input checked="" type="checkbox"/> Yes / <input type="checkbox"/> No	Reference: Report No. CN21GRDU 001, issued by TÜV Rheinland

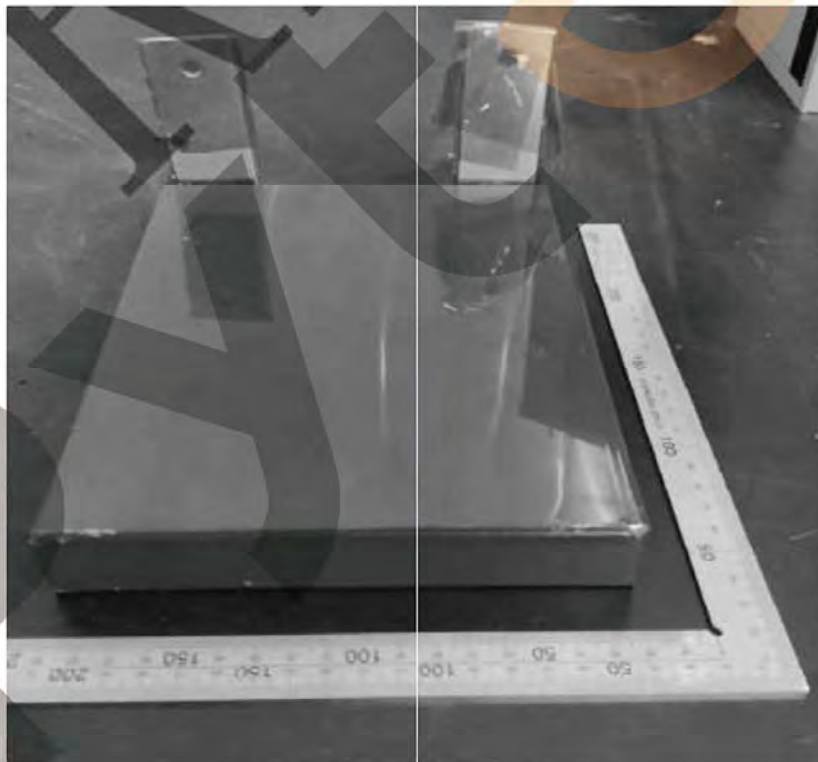

Figure 1. View of component cell



Unless otherwise agreed in writing, this document is issued by the Company subject to its General Conditions of Service printed overleaf, available on request or accessible at <https://www.sgs.com/en/terms-and-conditions>. Attention is drawn to the limitation of liability, indemnification and jurisdiction issues defined therein. Any holder of this document is advised that information contained hereon reflects the Company's findings at the time of its intervention only and within the limits of Client's instructions, if any. The Company's sole responsibility is to its Client and this document does not exonerate parties to a transaction from exercising all their rights and obligations under the transaction documents. This document cannot be reproduced except in full, without prior written approval of the Company. Any unauthorized alteration, forgery or falsification of the content or appearance of this document is unlawful and offenders may be prosecuted to the fullest extent of the law. Unless otherwise stated the results shown in this test report refer only to the sample(s) tested and such sample(s) are retained for 30 days only.

Attention: To check the authenticity of testing / inspection report & certificate, please contact us at telephone: (86-755) 8307 1443, or email: CN.Doccheck@sgs.com

SGS-CEC Technology (Chongqing) Co., Ltd. | 中国·重庆市江津区双福街道福云大道2号附6号 (重庆能源职业学院1#实验楼) | 邮编: 402280 | t: (86-23) 863676001 | www.sgs.com.cn | sgs.china@sgs.com

Table 2: Description of battery module

Model:	E-BOX-48100R	
Manufacturer:	Shanghai PYTES Energy CO., Ltd.	
Nominal capacity:	100 Ah	
Nominal voltage:	51.2 V	
Module designation:	Lithium ion, LiFePO ₄	
Maximum charge current:	100 A	
Maximum discharge current:	75 A	
Maximum charge voltage:	58 V	
Cut-off Voltage:	47.5 V	
Charge temperature range:	0°C to 45°C	
Discharge temperature range:	-10°C to 50°C	
Unit configuration:	16S	
External dimensions:	440mm*620mm*117mm	
Enclosure material:	Iron	
Weight:	Appr. 51Kg	
UL 1973 compliant:	<input type="checkbox"/> Yes / <input type="checkbox"/> No	N/A

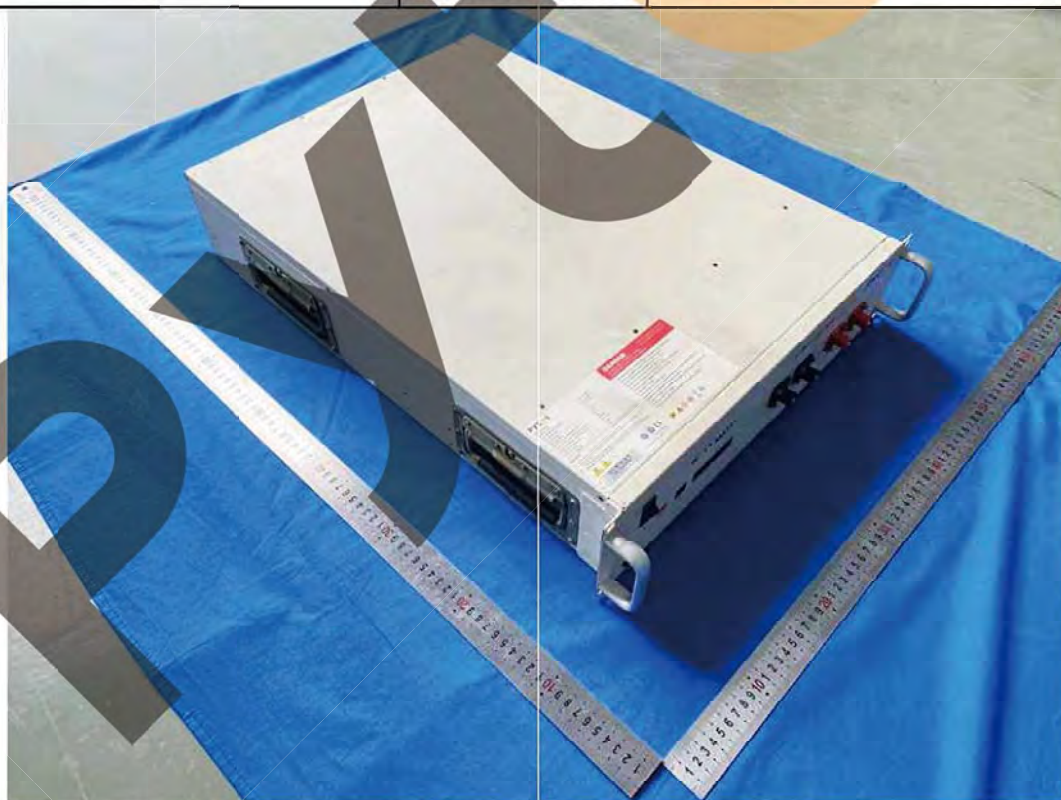

Figure 2a. External view of battery module



Unless otherwise agreed in writing, this document is issued by the Company subject to its General Conditions of Service printed overleaf, available on request or accessible at <https://www.sgs.com/en/terms-and-conditions>. Attention is drawn to the limitation of liability, indemnification and jurisdiction issues defined therein. Any holder of this document is advised that information contained hereon reflects the Company's findings at the time of its intervention only and within the limits of Client's instructions, if any. The Company's sole responsibility is to its Client and this document does not exonerate parties to a transaction from exercising all their rights and obligations under the transaction documents. This document cannot be reproduced except in full, without prior written approval of the Company. Any unauthorized alteration, forgery or falsification of the content or appearance of this document is unlawful and offenders may be prosecuted to the fullest extent of the law. Unless otherwise stated the results shown in this test report refer only to the sample(s) tested and such sample(s) are retained for 30 days only.

Attention: To check the authenticity of testing / inspection report & certificate, please contact us at telephone: (86-755) 8307 1443, or email: CN.Doccheck@sgs.com

SGS-CEC Energy Technology (Chongqing) Co., Ltd.

Address: No. 5, No. 2 Fuyun Road, Shanglu Street, Jangjin District, Chongqing, China (No. 1 Laboratory Building, Chongqing Energy College) 402260 t (86-23) 863676001 www.sgsgroup.com.cn
 中国·重庆市江津区双福街道福云大道2号附6号(重庆能源职业学院1#实验楼) 邮编: 402260 t (86-23) 863676001 sgs.china@sgs.com

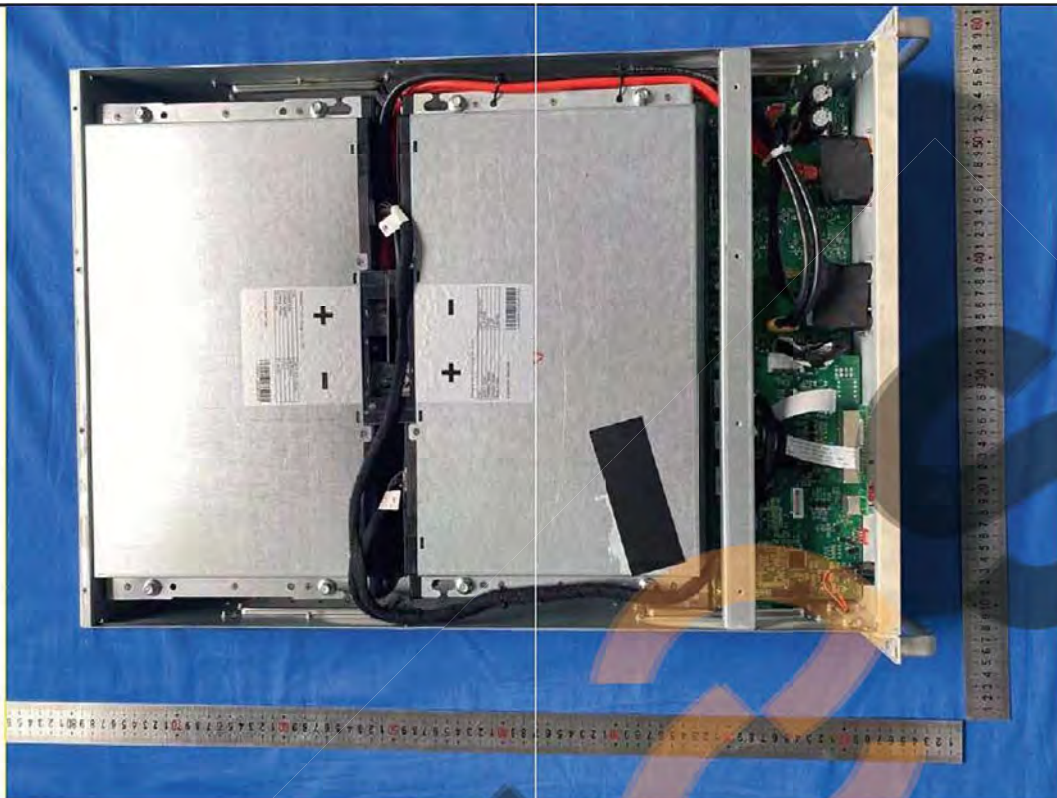

Figure 2b. Internal view of battery module

Deducted

Figure 2c. View 01 of BMS



Unless otherwise agreed in writing, this document is issued by the Company subject to its General Conditions of Service printed overleaf, available on request or accessible at <https://www.sgs.com/en/terms-and-conditions>. Attention is drawn to the limitation of liability, indemnification and jurisdiction issues defined therein. Any holder of this document is advised that information contained hereon reflects the Company's findings at the time of its intervention only and within the limits of Client's instructions, if any. The Company's sole responsibility is to its Client and this document does not exonerate parties to a transaction from exercising all their rights and obligations under the transaction documents. This document cannot be reproduced except in full, without prior written approval of the Company. Any unauthorized alteration, forgery or falsification of the content or appearance of this document is unlawful and offenders may be prosecuted to the fullest extent of the law. Unless otherwise stated the results shown in this test report refer only to the sample(s) tested and such sample(s) are retained for 30 days only.

Attention: To check the authenticity of testing / inspection report & certificate, please contact us at telephone: (86-755) 8307 1443, or email: CN.Doccheck@sgs.com

SGS-CHECHONG Technology (Chongqing) Co., Ltd. | 重庆新能技术(重庆)有限公司
 Address: No.5, No.2 Fuyun Road, Shangluo Street, Jiating District, Chongqing, China (No.1 Laboratory Building, Chongqing Energy College) 402260 t (86-23) 863676001 www.sgs.com.cn
 中国·重庆市江津区双福街道福云大道2号附6号(重庆能源职业学院1#实验楼) 邮编: 402260 t (86-23) 863676001 sgs.china@sgs.com

Deducted

ES

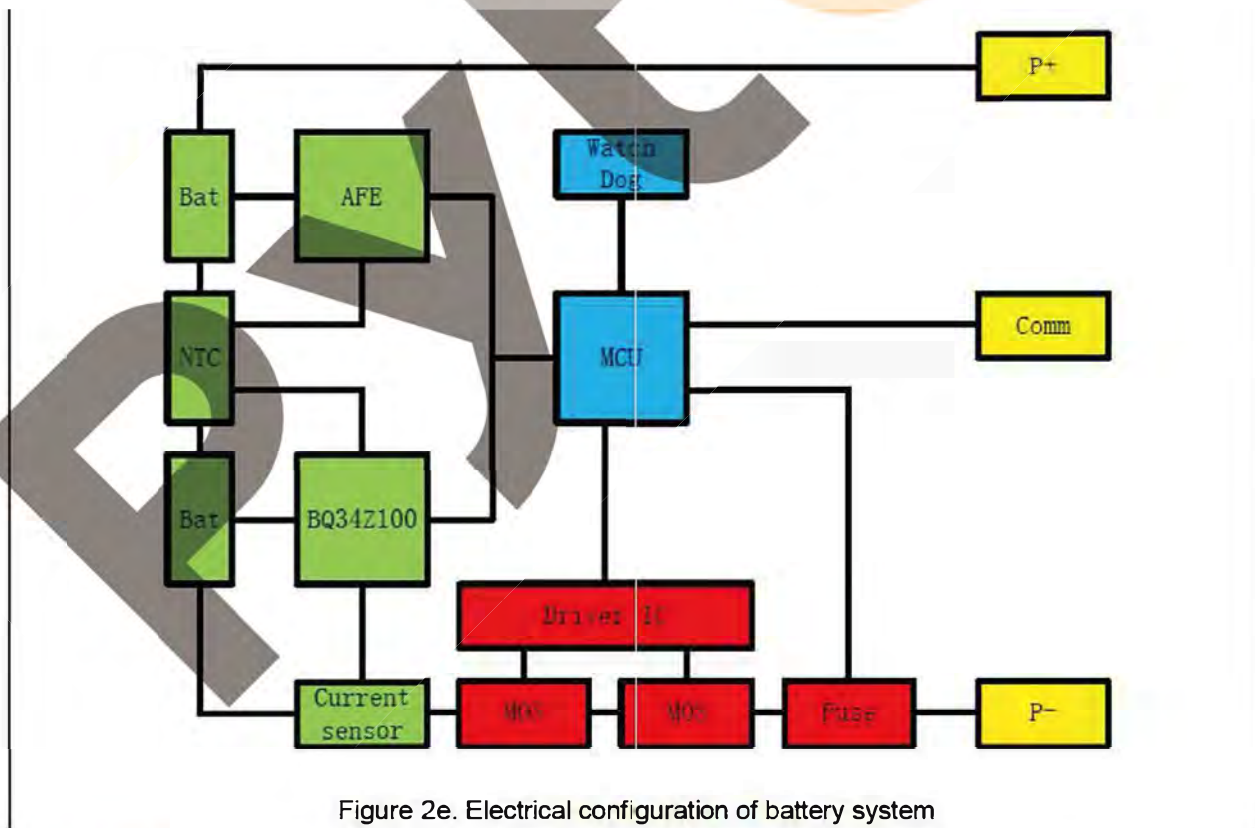

Figure 2e. Electrical configuration of battery system



Unless otherwise agreed in writing, this document is issued by the Company subject to its General Conditions of Service printed overleaf, available on request or accessible at <https://www.sgs.com/en/terms-and-conditions>. Attention is drawn to the limitation of liability, indemnification and jurisdiction issues defined therein. Any holder of this document is advised that information contained hereon reflects the Company's findings at the time of its intervention only and within the limits of Client's instructions, if any. The Company's sole responsibility is to its Client and this document does not exonerate parties to a transaction from exercising all their rights and obligations under the transaction documents. This document cannot be reproduced except in full, without prior written approval of the Company. Any unauthorized alteration, forgery or falsification of the content or appearance of this document is unlawful and offenders may be prosecuted to the fullest extent of the law. Unless otherwise stated the results shown in this test report refer only to the sample(s) tested and such sample(s) are retained for 30 days only.

Attention: To check the authenticity of testing / inspection report & certificate, please contact us at telephone: (86-755) 8307 1443, or email: CN.Doccheck@sgs.com

SGS-CEC Energy Technology (Chongqing) Co., Ltd. | Atilete No.5, No.2 Fuyun Road, Shanglu Street, Jiangjin District, Chongqing, China (No.1 Laboratory Building, Chongqing Energy College) 402260 | t (86-23) 863676001 | www.sgs.com.cn
 中国·重庆市江津区双福街道福云大道2号附6号(重庆能源职业学院1#实验楼) | 邮编: 402260 | t (86-23) 863676001 | sgs.china@sgs.com

Table 3: Description of battery unit

Model:	R-Bracket	
Manufacturer:	Shanghai PYTES Energy CO., Ltd.	
Nominal capacity:	100 Ah x 8	
Nominal voltage:	51.2 V	
Module designation:	Lithium ion, LiFePO ₄	
Maximum charge voltage:	58 V	
Cut-off Voltage:	47.5 V	
Charge temperature range:	0°C to 45°C	
Discharge temperature range:	-10°C to 50°C	
Unit configuration:	8P	
External dimensions:	525mm*725mm*1080mm	
Enclosure material:	Iron	
Fire suppression system contain	<input type="checkbox"/> Yes / <input checked="" type="checkbox"/> No	Reference: N/A
UL 1973 compliant:	<input type="checkbox"/> Yes / <input type="checkbox"/> No	Reference: N/A
UL 9540 compliant:	<input type="checkbox"/> Yes / <input type="checkbox"/> No	Reference: N/A

PYTES



Unless otherwise agreed in writing, this document is issued by the Company subject to its General Conditions of Service printed overleaf, available on request or accessible at <https://www.sgs.com/en/terms-and-conditions>. Attention is drawn to the limitation of liability, indemnification and jurisdiction issues defined therein. Any holder of this document is advised that information contained hereon reflects the Company's findings at the time of its intervention only and within the limits of Client's instructions, if any. The Company's sole responsibility is to its Client and this document does not exonerate parties to a transaction from exercising all their rights and obligations under the transaction documents. This document cannot be reproduced except in full, without prior written approval of the Company. Any unauthorized alteration, forgery or falsification of the content or appearance of this document is unlawful and offenders may be prosecuted to the fullest extent of the law. Unless otherwise stated the results shown in this test report refer only to the sample(s) tested and such sample(s) are retained for 30 days only.

Attention: To check the authenticity of testing / inspection report & certificate, please contact us at telephone: (86-755) 8307 1443, or email: CN.Doccheck@sgs.com

SGS-C.E.C. Energy Technology (Chongqing) Co., Ltd. | Affiliates No.6, No.2 Fuyun Road, Shuanglu Street, Jangjin District, Chongqing, China (No.1 Laboratory Building, Chongqing Energy College) 402260 | t: (86-23) 863676001 | www.sgs.com | 中国·重庆市江津区双福街道福云大道2号附6号(重庆能源职业学院1#实验楼) | 邮编: 402260 | t: (86-23) 863676001 | sgs.china@sgs.com



Figure 3a. View 01 of battery unit



Unless otherwise agreed in writing, this document is issued by the Company subject to its General Conditions of Service printed overleaf, available on request or accessible at <https://www.sgs.com/en/Terms-and-Conditions>. Attention is drawn to the limitation of liability, indemnification and jurisdiction issues defined therein. Any holder of this document is advised that information contained hereon reflects the Company's findings at the time of its intervention only and within the limits of Client's instructions, if any. The Company's sole responsibility is to its Client and this document does not exonerate parties to a transaction from exercising all their rights and obligations under the transaction documents. This document cannot be reproduced except in full, without prior written approval of the Company. Any unauthorized alteration, forgery or falsification of the content or appearance of this document is unlawful and offenders may be prosecuted to the fullest extent of the law. Unless otherwise stated the results shown in this test report refer only to the sample(s) tested and such sample(s) are retained for 30 days only.

Attention: To check the authenticity of testing/inspection report & certificate, please contact us at telephone: (86-755) 8307 1443, or email: CN.Doccheck@sgs.com

Affiliate No.5, No.2 Fuyun Road, Shuanglu Street, Jiating District, Chongqing, China (No.1 Laboratory Building, Chongqing Energy College) 402260 | (86-23) 863676001 | www.sgsgroup.com.cn
 中国·重庆市江津区双福街道福云大道2号附6号(重庆能源职业学院1#实验楼) 邮编: 402280 | (86-23) 863676001 | sgs.china@sgs.com



Figure 3b. View 02 of battery unit



Unless otherwise agreed in writing, this document is issued by the Company subject to its General Conditions of Service printed overleaf, available on request or accessible at <https://www.sgs.com/en/Terms-and-Conditions>. Attention is drawn to the limitation of liability, indemnification and jurisdiction issues defined therein. Any holder of this document is advised that information contained hereon reflects the Company's findings at the time of its intervention only and within the limits of Client's instructions, if any. The Company's sole responsibility is to its Client and this document does not exonerate parties to a transaction from exercising all their rights and obligations under the transaction documents. This document cannot be reproduced except in full, without prior written approval of the Company. Any unauthorized alteration, forgery or falsification of the content or appearance of this document is unlawful and offenders may be prosecuted to the fullest extent of the law. Unless otherwise stated the results shown in this test report refer only to the sample(s) tested and such sample(s) are retained for 30 days only.

Attention: To check the authenticity of testing /inspection report & certificate, please contact us at telephone: (86-755) 8307 1443, or email: CN.Doccheck@sgs.com

SGS-LEC (Chongqing) Technology (Group) Co., Ltd.

Affiliate No.5, No.2 Fuyun Road, Shuanglu Street, Jiating District, Chongqing, China (No.1 Laboratory Building, Chongqing Energy College) 402260 t (86-23) 863676001 www.sgsgroup.com.cn
 中国·重庆市江津区双福街道福云大道2号附6号(重庆能源职业学院1#实验楼) 邮编: 402280 t (86-23) 863676001 sgs.china@sgs.com

[Description of thermal runaway methodology]

Sample and test configuration

The unit level test shall be conducted with BESS (Battery Energy Storage System) units installed as described in the manufacturer's instructions and this section.

The unit level test requires one initiating BESS unit in which an internal fire condition in accordance with the module level test is initiated and target adjacent BESS units representative of an installation. Tests conducted for indoor floor mounted installations shall be considered representative of both indoor floor mounted and outdoor ground mounted installations with fire propagation hazards and separation distances between initiating and target units representative of the installation. Tests shall be conducted indoors with fire propagation hazards and separation distances between initiating and target units representative of the installation. The results of such tests shall be considered to also represent an outdoor installation.

Depending upon the configuration and design of the BESS (e.g. the BESS is composed of multiple separate parts within separate enclosures), this testing to determine fire characterization can be done at the battery system level. The suitability of this approach shall be determined based upon the overall design of the BESS and an analysis of the battery system as representative of the overall BESS for fire characterization concerns.

The initiating BESS unit shall contain components representative of a BESS unit in a complete installation. Combustible components that interconnect the initiating and target BESS units shall be included.

Target BESS units shall include the outer cabinet (if part of the design), racking, module enclosures, and components that retain cells components. The target BESS unit module enclosures do not need to contain cells.

The initiating BESS unit shall be at the maximum operating state of charge (MOSOC), in accordance with the manufacturer's specifications, for conducting the tests in this standard. After charging and prior to testing, the initiating BESS shall rest for a maximum period of 8 h at room ambient.

If a BESS unit includes an integral fire suppression system, there is an option of providing this with the DUT. If the BESS unit is provided with an optional integral fire suppression system, the system shall not be provided on the DUT.

Electronics and software controls such as the battery management system (BMS) in the BESS are not relied upon for this testing. This does not include a fire suppression control in accordance with UL 840 that is external to the BESS, but provided as part of an integral fire suppression system.

Table 4: Integral fire suppression system information

Integral fire suppression system information	No integral fire suppression system
Standard or optional	<input type="checkbox"/> Standard / <input type="checkbox"/> optional / <input checked="" type="checkbox"/> N/A
Test with fire suppression or not	<input type="checkbox"/> Yes / <input checked="" type="checkbox"/> No



Unless otherwise agreed in writing, this document is issued by the Company subject to its General Conditions of Service printed overleaf, available on request or accessible at <https://www.sgs.com/en/Terms-and-Conditions>. Attention is drawn to the limitation of liability, indemnification and jurisdiction issues defined therein. Any holder of this document is advised that information contained hereon reflects the Company's findings at the time of its intervention only and within the limits of Client's instructions, if any. The Company's sole responsibility is to its Client and this document does not exonerate parties to a transaction from exercising all their rights and obligations under the transaction documents. This document cannot be reproduced except in full, without prior written approval of the Company. Any unauthorized alteration, forgery or falsification of the content or appearance of this document is unlawful and offenders may be prosecuted to the fullest extent of the law. Unless otherwise stated the results shown in this test report refer only to the sample(s) tested and such sample(s) are retained for 30 days only.

Attention: To check the authenticity of testing / inspection report & certificate, please contact us at telephone: (86-755) 8307 1443, or email: CN.Doccheck@sgs.com

Affiliate No.5, No.2 Fuyun Road, Shuanglu Street, Jiating District, Chongqing, China (No.1 Laboratory Building, Chongqing Energy College) 402260 | (86-23) 863676001 | www.sgs.com
 中国·重庆市江津区双福街道福云大道2号附6号(重庆能源职业学院1#实验楼幢) 邮编: 402280 | (86-23) 863676001 | sgs.china@sgs.com

Table 5: BESS installations/ Test configurations

Description:		
<input type="checkbox"/>	a) Indoor floor mounted non-residential use BESS	
<input checked="" type="checkbox"/>	b) Indoor floor mounted residential use BESS	
<input type="checkbox"/>	c) Outdoor ground mounted non-residential use BESS	
<input type="checkbox"/>	d) Outdoor ground mounted residential use BESS	
<input type="checkbox"/>	e) Indoor wall mounted non-residential use BESS	
<input type="checkbox"/>	f) Indoor wall mounted residential use BESS	
<input type="checkbox"/>	g) Outdoor wall mounted non-residential use BESS	
<input type="checkbox"/>	h) Outdoor wall mounted residential use BESS	
<input type="checkbox"/>	i) Rooftop garage non-residential use BESS	
<input type="checkbox"/>	j) Open garage non-residential use BESS	
Test configurations for Indoor floor mounted residential use BESS		
	A	50 mm
	B	50 mm
	C	50 mm
	D	0 mm
	E	0 mm
	F	0 mm
	G	50 mm
	H	0 mm



Unless otherwise agreed in writing, this document is issued by the Company subject to its General Conditions of Service printed overleaf, available on request or accessible at <https://www.sgs.com/en/Terms-and-Conditions>. Attention is drawn to the limitation of liability, indemnification and jurisdiction issues defined therein. Any holder of this document is advised that information contained hereon reflects the Company's findings at the time of its intervention only and within the limits of Client's instructions, if any. The Company's sole responsibility is to its Client and this document does not exonerate parties to a transaction from exercising all their rights and obligations under the transaction documents. This document cannot be reproduced except in full, without prior written approval of the Company. Any unauthorized alteration, forgery or falsification of the content or appearance of this document is unlawful and offenders may be prosecuted to the fullest extent of the law. Unless otherwise stated the results shown in this test report refer only to the sample(s) tested and such sample(s) are retained for 30 days only.

Attention: To check the authenticity of testing/inspection report & certificate, please contact us at telephone: (86-755) 8307 1443, or email: CN.Doccheck@sgs.com

Affiliate No.5, No.2 Fuyun Road, Shuanglu Street, Jiating District, Chongqing, China (No.1 Laboratory Building, Chongqing Energy College) 402260 | (86-23) 863676001 | www.sgs.com
 中国·重庆市江津区双福街道福云大道2号附6号(重庆能源职业学院1#实验楼) 邮编: 402260 | (86-23) 863676001 | sgs.china@sgs.com

Unit level Test method description

Test method – Indoor floor mounted BESS units

Samples and test configurations are in accordance with Table 5. During the test, the test room environment shall be controlled to prevent drafts that may affect test results. At the start of the test, the room ambient temperature shall not be less than 10°C (50°F) nor more than 32°C (90°F).

Any access door(s) or panels on the initiating BESS unit and adjacent target BESS units shall be closed, latched and locked at the beginning and duration of the test.

The initiating BESS unit shall be positioned adjacent to two instrumented wall sections.

Instrumented wall sections shall extend not less than 1.6 ft (0.49 m) horizontally beyond the exterior of the target BESS units.

The surface of the instrumented wall sections shall be covered with 16-mm (5/8-in) gypsum wall board and painted flat black. The initiating BESS unit shall be centered underneath an appropriately sized smoke collection hood of an oxygen consumption calorimeter.

The light transmission in the calorimeter's exhaust duct shall be measured using a white light source and photo detector for the duration of the test, and the smoke release rate shall be calculated.

The chemical and convective heat release rates shall be measured for the duration of the test. The heat release rate measurement system shall be calibrated using an atomized heptane diffusion burner. The calibration shall be performed using flows of 3.8, 7.6, 11.4 and 15.2 L/min (1, 2, 3 and 4 gpm) of heptane.

The convective heat release rate shall be measured using thermopile, a velocity probe, and a Type K thermocouple, located in the exhaust system of the exhaust duct. The convective heat release rate shall be calculated using the following equation:

$$HRR_c = V_e A \frac{353.22}{T_e} \int_{T_0}^T C_p dT$$

The physical spacing between BESS units (both initiating and target) and adjacent walls shall be representative of the intended installation.

Separation distances shall be specified by the manufacturer for distance between:

- The BESS units and the instrumented wall sections; and
- Adjacent BESS units.

Wall surface temperature measurements shall be collected for BESS intended for installation in locations with combustible construction. If the intended installation is composed completely of noncombustible construction in which wall assemblies, cables, wiring and any other combustible materials are not to be present in the BESS installation, then the report should note that the installation shall contain no combustible construction and that surface temperature rises can be deemed not applicable.

Wall surface temperatures shall be measured in vertical array(s) at 152-mm (6-in) intervals for the full height of the instrumented wall sections using No. 24-gauge or smaller, Type-K exposed junction thermocouples. The thermocouples for measuring the temperature on wall surfaces shall be horizontally positioned in the wall locations anticipated to receive the greatest thermal exposure from the initiating BESS unit.



Unless otherwise agreed in writing, this document is issued by the Company subject to its General Conditions of Service printed overleaf, available on request or accessible at <https://www.sgs.com/en/Terms-and-Conditions>. Attention is drawn to the limitation of liability, indemnification and jurisdiction issues defined therein. Any holder of this document is advised that information contained hereon reflects the Company's findings at the time of its intervention only and within the limits of Client's instructions, if any. The Company's sole responsibility is to its Client and this document does not exonerate parties to a transaction from exercising all their rights and obligations under the transaction documents. This document cannot be reproduced except in full, without prior written approval of the Company. Any unauthorized alteration, forgery or falsification of the content or appearance of this document is unlawful and offenders may be prosecuted to the fullest extent of the law. Unless otherwise stated the results shown in this test report refer only to the sample(s) tested and such sample(s) are retained for 30 days only.

Attention: To check the authenticity of testing / inspection report & certificate, please contact us at telephone: (86-755) 8307 1443, or email: CN.Doccheck@sgs.com

Affiliate No.5, No.2 Fuyun Road, Shuanglu Street, Jiating District, Chongqing, China (No.1 Laboratory Building, Chongqing Energy College) 402260 t (86-23) 863676001 www.sgs.com.cn
 中国·重庆市江津区双福街道福云大道2号附6号(重庆能源职业学院1#实验楼) 邮编: 402260 t (86-23) 863676001 sgs.china@sgs.com

Thermocouples shall be secured to gypsum surfaces by the use of staples placed over the insulated portion of the wires. The thermocouple tip shall be depressed into the gypsum so as to be flush with the gypsum surface at the point of measurement and held in thermal contact with the surface at that point by the use of pressure-sensitive paper tape.

Heat flux shall be measured with the sensing element of at least two water-cooled Schmidt-Boelter gauges at the surface of each instrumented wall:

- a) Both are collinear with the vertical thermocouple array;
- b) One is positioned at the elevation estimated to receive the greatest heat flux due to the thermal runaway of the initiating module; and
- c) One is positioned at the elevation estimated to receive the greatest heat flux during potential propagation of thermal runaway within the initiating BESS unit.

Heat flux shall be measured with the sensing element of at least two water-cooled Schmidt-Boelter gauges at the surface of each adjacent target BESS unit that faces the initiating BESS unit:

- a) One is positioned at the elevation estimated to receive the greatest heat flux due to the thermal runaway of the initiating module within the initiating BESS; and
- b) One is positioned at the elevation estimated to receive the greatest surface heat flux due to the thermal runaway of the initiating BESS.

For non-residential use BESS, heat flux shall be measured with the sensing element of at least one water-cooled Schmidt-Boelter gauge positioned at the mid height of the initiating unit in the center of the accessible means of egress.

No. 24-gauge or smaller, Type-K exposed junction thermocouples shall be installed to measure the temperature of the surface proximate to the cells and between the cells and exposed face of the initiating module. Each non-initiating module enclosure within the initiating BESS unit shall be instrumented with at least one No. 24-gauge or smaller Type-K thermocouple(s) to provide data to monitor the thermal conditions within non-initiating modules. Additional thermocouples shall be placed to account for convoluted enclosure interior geometries.

For residential use BESS, the DUT shall be covered with a single layer of cheese cloth ignition indicator. The cheesecloth shall be untreated cotton cloth running 26 – 28 m²/kg with a count of 28 – 32 threads in either direction within a 6.45 cm² (1 in²) area.

An internal fire condition in accordance with the module level test shall be created within a single module in the initiating BESS unit:

- a) The position of the module shall be selected to present the greatest thermal exposure to adjacent modules (e.g. above, below, laterally), based on the results from the module level test; and
- b) The setup (i.e. type, quantity and positioning) of equipment for initiating thermal runaway in the module shall be the same as that used to initiate and propagate thermal runaway within the module level test.

Thermal runaway methodology for unit level test:

The propensity of the cell to exhibit thermal runaway be demonstrated by heating the cell with externally applied heaters. With a surface heating rate of 4°C (7.2°F) to 7°C (12.6°F) per minute until cell thermal runaway occurs within the test unit.

The composition, velocity and temperature of the initiating BESS unit vent gases shall be measured within the calorimeter's exhaust duct. Gas composition shall be measured using a Fourier-Transform Infrared Spectrometer with a minimum resolution of 1 cm⁻¹ and a path length of at least 2.0 m(6.6 ft), or equivalent gas analyzer. Composition, velocity and temperature instrumentation shall be collocated with heat release rate calorimetry instrumentation.

The hydrocarbon content of the vent gas shall be measured using flame ionization detection.

The test shall be terminated if:



Unless otherwise agreed in writing, this document is issued by the Company subject to its General Conditions of Service printed overleaf, available on request or accessible at <https://www.sgs.com/en/Terms-and-Conditions>. Attention is drawn to the limitation of liability, indemnification and jurisdiction issues defined therein. Any holder of this document is advised that information contained hereon reflects the Company's findings at the time of its intervention only and within the limits of Client's instructions, if any. The Company's sole responsibility is to its Client and this document does not exonerate parties to a transaction from exercising all their rights and obligations under the transaction documents. This document cannot be reproduced except in full, without prior written approval of the Company. Any unauthorized alteration, forgery or falsification of the content or appearance of this document is unlawful and offenders may be prosecuted to the fullest extent of the law. Unless otherwise stated the results shown in this test report refer only to the sample(s) tested and such sample(s) are retained for 30 days only.

Attention: To check the authenticity of testing/inspection report & certificate, please contact us at telephone: (86-755) 8307 1443, or email: CN.Doccheck@sgs.com

Affiliate No.5, No.2 Fajun Road, Shuanglu Street, Jiating District, Chongqing, China (No.1 Laboratory Building, Chongqing Energy College) 402260 t (86-23) 863676001 www.sgs.com.cn
 中国·重庆市江津区双福街道福云大道2号附6号(重庆能源职业学院1#实验楼) 邮编: 402280 t (86-23) 863676001 sgs.china@sgs.com

- a) Temperatures measured inside each module within the initiating BESS unit return to ambient temperature;
- b) The fire propagates to adjacent units or to adjacent walls; or
- c) A condition hazardous to test staff or the test facility requires mitigation.

For residential use systems, the gas collection data gathered shall be compared to the smallest room installation specified by the manufacturer to determine if the flammable gas collected exceeds 25% LFL in air.

PRELIMS



Unless otherwise agreed in writing, this document is issued by the Company subject to its General Conditions of Service printed overleaf, available on request or accessible at <https://www.sgs.com/en/Terms-and-Conditions>. Attention is drawn to the limitation of liability, indemnification and jurisdiction issues defined therein. Any holder of this document is advised that information contained hereon reflects the Company's findings at the time of its intervention only and within the limits of Client's instructions, if any. The Company's sole responsibility is to its Client and this document does not exonerate parties to a transaction from exercising all their rights and obligations under the transaction documents. This document cannot be reproduced except in full, without prior written approval of the Company. Any unauthorized alteration, forgery or falsification of the content or appearance of this document is unlawful and offenders may be prosecuted to the fullest extent of the law. Unless otherwise stated the results shown in this test report refer only to the sample(s) tested and such sample(s) are retained for 30 days only.

Attention: To check the authenticity of testing / inspection report & certificate, please contact us at telephone: (86-755) 8307 1443, or email: CN.Doccheck@sgs.com

SGS-CEC (Chongqing) Technology (Group) Co., Ltd.

Affiliate No.5, No.2 Fajun Road, Shuanglu Street, Jiating District, Chongqing, China (No.1 Laboratory Building, Chongqing Energy College) 402260 | (86-23) 863676001 | www.sgsgroup.com.cn
中国·重庆市江津区双福街道福云大道2号附6号(重庆能源职业学院1#实验楼幢) 邮编: 402280 | (86-23) 863676001 | sgs.china@sgs.com

Test configuration description

Illustration of the initiating BESS unit	
Description: N/A	
<p>Figure 4. View of the initiating BESS unit before test.</p>	



Unless otherwise agreed in writing, this document is issued by the Company subject to its General Conditions of Service printed overleaf, available on request or accessible at <https://www.sgs.com/en/Terms-and-Conditions>. Attention is drawn to the limitation of liability, indemnification and jurisdiction issues defined therein. Any holder of this document is advised that information contained hereon reflects the Company's findings at the time of its intervention only and within the limits of Client's instructions, if any. The Company's sole responsibility is to its Client and this document does not exonerate parties to a transaction from exercising all their rights and obligations under the transaction documents. This document cannot be reproduced except in full, without prior written approval of the Company. Any unauthorized alteration, forgery or falsification of the content or appearance of this document is unlawful and offenders may be prosecuted to the fullest extent of the law. Unless otherwise stated the results shown in this test report refer only to the sample(s) tested and such sample(s) are retained for 30 days only.

Attention: To check the authenticity of testing /inspection report & certificate, please contact us at telephone: (86-755) 8307 1443, or email: CN.Doccheck@sgs.com

SGS-CEC (重庆) 能源技术(重庆)有限公司 | Affiliates No.5, No.2 Fuyun Road, Shuangshi Street, Jiating District, Chongqing, China (No.1 Laboratory Building, Chongqing Energy College) 402260 | (86-23) 863676001 | www.sgsgroup.com.cn
 中国·重庆市江津区双福街道福云大道2号附6号(重庆能源职业学院1#实验楼) 邮编: 402280 | (86-23) 863676001 | sgs.china@sgs.com

Thermal runaway initiation method used (including number and locations of cells for initiating thermal runaway)

Initiation method:

External heating method was used to initiate thermal runaway. 2 heaters were used to initiate thermal runaway. Heater 1 was placed between the large surfaces of Cell 2 and Cell 3. Heater 2 was placed between the large surfaces of Cell 3 and Cell 4. Cell 3 was selected as initiating cell. Each heater was connected to one voltage regulator.

Heater 1 and Heater 2 were energized at the same time. The working currents of Heater 1 and Heater 2 were continuously adjusted to make sure that the initiating cell was heated at a ramp of 4-7 °C/min.

Number of cells for initiating thermal runaway:

- Single cell 100 Ah (total capacity)
- Multiple cell Ah (total capacity)

Locations of cells for initiating thermal runaway: The initiating battery module consists of 2 submodules. Each submodule consists of 8 cells with a connection mode of 8S. Two submodules are connected in series. One 8S submodule (as shown in Figure 5c) is selected as the initiating submodule. heaters were placed on large face of cell 3. Cell 3 is selected as the initiating cell.

Other description: N/A



Figure 5a. External view of battery module.

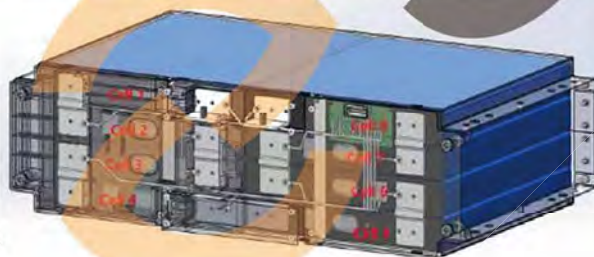

Figure 5b. Internal schematic view of battery module.



Figure 5c. Internal view 03 of battery module.

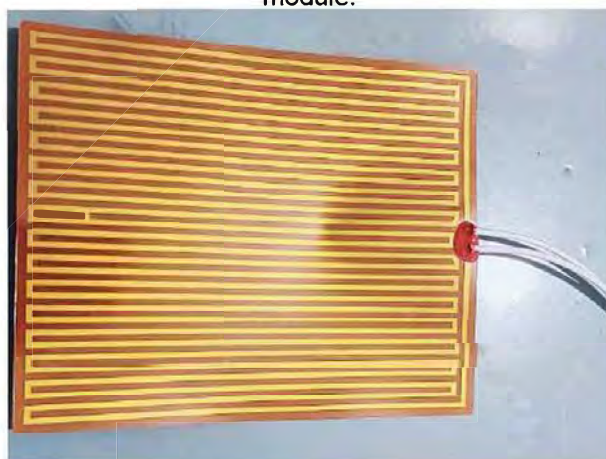

Figure 5d. View of heater.



Unless otherwise agreed in writing, this document is issued by the Company subject to its General Conditions of Service printed overleaf, available on request or accessible at <https://www.sgs.com/en/terms-and-conditions>. Attention is drawn to the limitation of liability, indemnification and jurisdiction issues defined therein. Any holder of this document is advised that information contained hereon reflects the Company's findings at the time of its intervention only and within the limits of Client's instructions, if any. The Company's sole responsibility is to its Client and this document does not exonerate parties to a transaction from exercising all their rights and obligations under the transaction documents. This document cannot be reproduced except in full, without prior written approval of the Company. Any unauthorized alteration, forgery or falsification of the content or appearance of this document is unlawful and offenders may be prosecuted to the fullest extent of the law. Unless otherwise stated the results shown in this test report refer only to the sample(s) tested and such sample(s) are retained for 30 days only.

Attention: To check the authenticity of testing / inspection report & certificate, please contact us at telephone: (86-755) 8307 1443, or e-mail: CN.Doccheck@sgs.com

SGS-CQEC (Chongqing) Inspection & Testing Services Co., Ltd.

Address: No.5, No.2 Fuyun Road, Shuanglu Street, Jangjin District, Chongqing, China (No.1 Laboratory Building, Chongqing Energy College) 402260 t (86-23) 863676001 www.sgs.com.cn
 中国·重庆市江津区双福街道福云大道2号附6号(重庆能源职业学院1#实验楼) 邮编: 402260 t (86-23) 863676001 sgs.china@sgs.com

Illustration of external heater and thermocouple location

Description: N/A

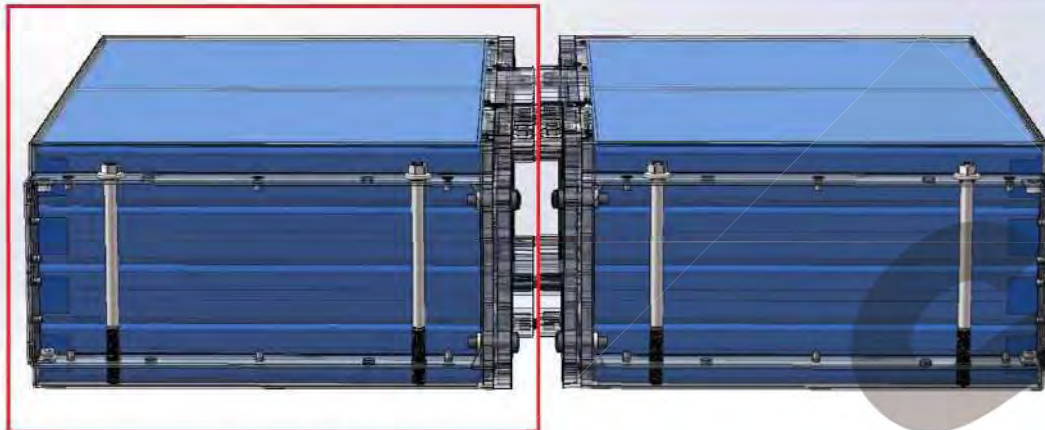

Figure 6a. Schematic diagram of initiating module.

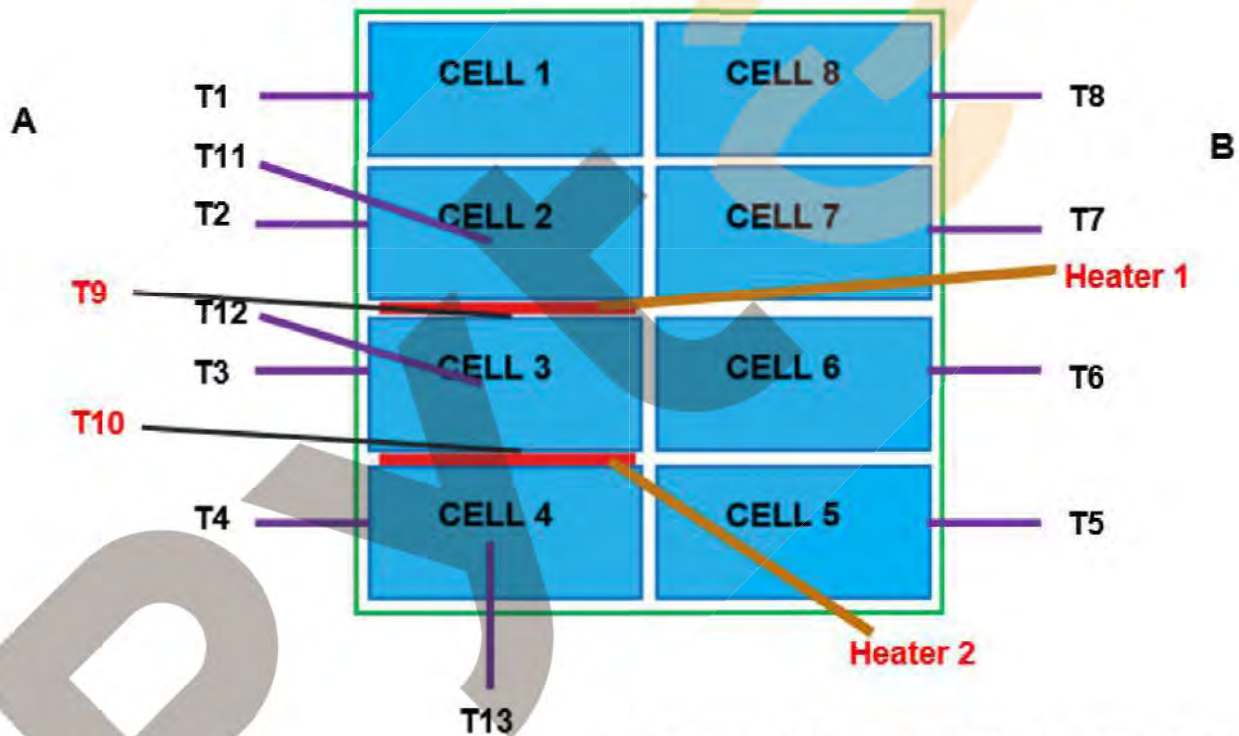

Figure 6b. Schematic diagram of external heater and thermocouple locations in the initiating module (Side view).



Unless otherwise agreed in writing, this document is issued by the Company subject to its General Conditions of Service printed overleaf, available on request or accessible at <https://www.sgs.com/en/Terms-and-Conditions>. Attention is drawn to the limitation of liability, indemnification and jurisdiction issues defined therein. Any holder of this document is advised that information contained hereon reflects the Company's findings at the time of its intervention only and within the limits of Client's instructions, if any. The Company's sole responsibility is to its Client and this document does not exonerate parties to a transaction from exercising all their rights and obligations under the transaction documents. This document cannot be reproduced except in full, without prior written approval of the Company. Any unauthorized alteration, forgery or falsification of the content or appearance of this document is unlawful and offenders may be prosecuted to the fullest extent of the law. Unless otherwise stated the results shown in this test report refer only to the sample(s) tested and such sample(s) are retained for 30 days only.

Attention: To check the authenticity of testing/inspection report & certificate, please contact us at telephone: (86-755) 8307 1443, or email: CN.Doccheck@sgs.com

Affiliate No.5, No.2 Fuyun Road, Shuanglu Street, Jiating District, Chongqing, China (No.1 Laboratory Building, Chongqing Energy College) 402260 | (86-23) 863676001 | www.sgsgroup.com.cn
 中国·重庆市江津区双福街道福云大道2号附6号(重庆能源职业学院1#实验楼幢) 邮编: 402280 | (86-23) 863676001 | sgs.china@sgs.com

Positioning of units within testing room
Test Start Time: 2022-08-09 14:42:00
Initial Ambient Test Temperature: 28.8 °C
Initial Relative Humidity: 58%
Description: N/A



Figure 7. View of BESS within test room.



Unless otherwise agreed in writing, this document is issued by the Company subject to its General Conditions of Service printed overleaf, available on request or accessible at <https://www.sgs.com/en/Terms-and-Conditions>. Attention is drawn to the limitation of liability, indemnification and jurisdiction issues defined therein. Any holder of this document is advised that information contained hereon reflects the Company's findings at the time of its intervention only and within the limits of Client's instructions, if any. The Company's sole responsibility is to its Client and this document does not exonerate parties to a transaction from exercising all their rights and obligations under the transaction documents. This document cannot be reproduced except in full, without prior written approval of the Company. Any unauthorized alteration, forgery or falsification of the content or appearance of this document is unlawful and offenders may be prosecuted to the fullest extent of the law. Unless otherwise stated the results shown in this test report refer only to the sample(s) tested and such sample(s) are retained for 30 days only.

Attention: To check the authenticity of testing /inspection report & certificate, please contact us at telephone: (86-755) 8307 1443, or email: CN.Doccheck@sgs.com

SGS-CEC (Chongqing Energy College) Technology Co., Ltd.

Affiliate No.5, No.2 Fuyun Road, Shuanglu Street, Jiating District, Chongqing, China (No.1 Laboratory Building, Chongqing Energy College) 402260 t (86-23) 863676001 www.sgsgroup.com.cn
 中国·重庆市江津区双福街道福云大道2号附6号(重庆能源职业学院1#实验楼) 邮编: 402280 t (86-23) 863676001 sgs.china@sgs.com

Table 6: Thermocouple placement

Thermocouple ID	Description of location	Remark
CH2501	Side surface A of Cell 1	T1, in initiating module
CH2502	Side surface A of Cell 2	T2, in initiating module
CH2503	Side surface A of Cell 3	T3, in initiating module
CH2504	Side surface A of Cell 4	T4, in initiating module
CH2505	Side surface B of Cell 5	T5, in initiating module
CH2506	Side surface B of Cell 6	T6, in initiating module
CH2507	Side surface B of Cell 7	T7, in initiating module
CH2508	Side surface B of Cell 8	T8, in initiating module
CH2509	Large surface of cell 3, between cell surface and Heater 1	T9, in initiating module
CH2510	Large surface of cell 3, between cell surface and Heater 2	T10, in initiating module
CH3001	Bottom surface of cell 2	T11, in initiating module
CH3002	Bottom surface of cell 3	T12, in initiating module
CH3003	Bottom surface of cell 4	T13, in initiating module
CH2001	No. 1 of wall B	WB-1
CH2002	No. 2 of wall B	WB-2
CH2003	No. 3 of wall B	WB-3
CH2004	No. 4 of wall B	WB-4
CH2005	No. 5 of wall B	WB-5
CH2006	No. 6 of wall B	WB-6
CH2007	No. 7 of wall B	WB-7
CH2008	No. 8 of wall B	WB-8
CH2009	No. 9 of wall B	WB-9
CH2010	No. 10 of wall B	WB-10
CH2101	No. 11 of wall B	WB-11
CH2102	No. 12 of wall B	WB-12
CH2103	No. 13 of wall B	WB-13
CH2104	No. 14 of wall B	WB-14
CH2105	No. 15 of wall B	WB-15
CH2106	No. 16 of wall B	WB-16
CH2107	No. 17 of wall B	WB-17
CH2108	No. 18 of wall B	WB-18



Unless otherwise agreed in writing, this document is issued by the Company subject to its General Conditions of Service printed overleaf, available on request or accessible at <https://www.sgs.com/en/Terms-and-Conditions>. Attention is drawn to the limitation of liability, indemnification and jurisdiction issues defined therein. Any holder of this document is advised that information contained herein reflects the Company's findings at the time of its intervention only and within the limits of Client's instructions, if any. The Company's sole responsibility is to its Client and this document does not exonerate parties to a transaction from exercising all their rights and obligations under the transaction documents. This document cannot be reproduced except in full, without prior written approval of the Company. Any unauthorized alteration, forgery or falsification of the content or appearance of this document is unlawful and offenders may be prosecuted to the fullest extent of the law. Unless otherwise stated the results shown in this test report refer only to the sample(s) tested and such sample(s) are retained for 30 days only.

Attention: To check the authenticity of testing/inspection report & certificate, please contact us at telephone: (+86-755) 8307 1443, or email: CN.Doccheck@sgs.com
 Affiliates No.5, No.2 Fajun Road, Shuanglu Street, Jiating District, Chongqing, China (No.1 Laboratory Building, Chongqing Energy College) 402260 | (+86-23) 863676001 | www.sgsgroup.com.cn
 中国·重庆市江津区双福街道福云大道2号附6号(重庆能源职业学院1#实验楼) 邮编: 402280 | (+86-23) 863676001 | sgs.china@sgs.com

CH2109	No. 19 of wall B	WB-19
CH2110	No. 20 of wall B	WB-20
CH2201	No. 21 of wall B	WB-21
CH2202	No. 22 of wall B	WB-22
CH2203	No. 23 of wall B	WB-23
CH2204	No. 24 of wall B	WB-24
CH1001	No. 25 of wall B	WB-25
CH1002	No. 26 of wall B	WB-26
CH1003	No. 27 of wall B	WB-27
CH1004	No. 28 of wall B	WB-28
CH1005	No. 29 of wall B	WB-29
CH1006	No. 30 of wall B	WB-30
CH1007	No. 31 of wall B	WB-31
CH1008	No. 32 of wall B	WB-32
CH1009	No. 33 of wall B	WB-33
CH1010	No. 34 of wall B	WB-34
CH1101	No. 35 of wall B	WB-35
CH1102	No. 36 of wall B	WB-36
CH1103	No. 37 of wall B	WB-37
CH1104	No. 38 of wall B	WB-38
CH1105	No. 39 of wall B	WB-39
CH1106	No. 40 of wall B	WB-40
CH1107	No. 41 of wall B	WB-41
CH1108	No. 42 of wall B	WB-42
CH1201	No. 43 of wall B	WB-43
CH1202	No. 44 of wall B	WB-44
CH1203	No. 45 of wall B	WB-45
CH1204	No. 46 of wall B	WB-46
CH1205	No. 47 of wall B	WB-47
CH1206	No. 48 of wall B	WB-48
CH1207	No. 49 of wall B	WB-49
CH1208	No. 50 of wall B	WB-50



Unless otherwise agreed in writing, this document is issued by the Company subject to its General Conditions of Service printed overleaf, available on request or accessible at <https://www.sgs.com/en/Terms-and-Conditions>. Attention is drawn to the limitation of liability, indemnification and jurisdiction issues defined therein. Any holder of this document is advised that information contained herein reflects the Company's findings at the time of its intervention only and within the limits of Client's instructions, if any. The Company's sole responsibility is to its Client and this document does not exonerate parties to a transaction from exercising all their rights and obligations under the transaction documents. This document cannot be reproduced except in full, without prior written approval of the Company. Any unauthorized alteration, forgery or falsification of the content or appearance of this document is unlawful and offenders may be prosecuted to the fullest extent of the law. Unless otherwise stated the results shown in this test report refer only to the sample(s) tested and such sample(s) are retained for 30 days only.

Attention: To check the authenticity of testing / inspection report & certificate, please contact us at telephone: (+86-755) 8307 1443, or email: CN.Doccheck@sgs.com

Affiliate No.5, No.2 Fajun Road, Shuanglu Street, Jiating District, Chongqing, China (No.1 Laboratory Building, Chongqing Energy College) 402260 | (86-23) 863676001 | www.sgsgroup.com.cn
 中国·重庆市江津区双福街道福云大道2号附6号(重庆能源职业学院1#实验楼幢) 邮编: 402260 | (86-23) 863676001 | sgs.china@sgs.com

CH1209	No. 51 of wall B	WB-51
CH1210	No. 52 of wall B	WB-52
CH1301	No. 53 of wall B	WB-52
CH1302	No. 54 of wall B	WB-54
CH0001	No. 1 of wall A	WA-1
CH0002	No. 2 of wall A	WA-2
CH0003	No. 3 of wall A	WA-3
CH0004	No. 4 of wall A	WA-4
CH0005	No. 5 of wall A	WA-5
CH0006	No. 6 of wall A	WA-6
CH0007	No. 7 of wall A	WA-7
CH0009	No. 8 of wall A	WA-8
CH0010	No. 9 of wall A	WA-9
CH0101	No. 10 of wall A	WA-10
CH0103	No. 11 of wall A	WA-11
CH0104	No. 12 of wall A	WA-12
CH0105	No. 13 of wall A	WA-13
CH0106	No. 14 of wall A	WA-14
CH0107	No. 15 of wall A	WA-15
CH0108	No. 16 of wall A	WA-16
CH0109	No. 17 of wall A	WA-17
CH0110	No. 18 of wall A	WA-18
CH0201	No. 19 of wall A	WA-19
CH0202	No. 20 of wall A	WA-20
CH0203	No. 21 of wall A	WA-21
CH0204	No. 22 of wall A	WA-22
CH2205	No. 23 of wall A	WA-23
CH2206	No. 24 of wall A	WA-24
CH2207	No. 25 of wall A	WA-25
CH2208	No. 26 of wall A	WA-26
CH2209	No. 27 of wall A	WA-27
CH2210	No. 28 of wall A	WA-28



Unless otherwise agreed in writing, this document is issued by the Company subject to its General Conditions of Service printed overleaf, available on request or accessible at <https://www.sgs.com/en/Terms-and-Conditions>. Attention is drawn to the limitation of liability, indemnification and jurisdiction issues defined therein. Any holder of this document is advised that information contained herein reflects the Company's findings at the time of its intervention only and within the limits of Client's instructions, if any. The Company's sole responsibility is to its Client and this document does not exonerate parties to a transaction from exercising all their rights and obligations under the transaction documents. This document cannot be reproduced except in full, without prior written approval of the Company. Any unauthorized alteration, forgery or falsification of the content or appearance of this document is unlawful and offenders may be prosecuted to the fullest extent of the law. Unless otherwise stated the results shown in this test report refer only to the sample(s) tested and such sample(s) are retained for 30 days only.

Attention: To check the authenticity of testing / inspection report & certificate, please contact us at telephone: (+86-755) 8307 1443, or email: CN.Doccheck@sgs.com

Affiliate No.5, No.2 Fajun Road, Shuanglu Street, Jiating District, Chongqing, China (No.1 Laboratory Building, Chongqing Energy College) 402260 | (+86-23) 863676001 | www.sgsgroup.com.cn
 中国·重庆市江津区双福街道福云大道2号附6号(重庆能源职业学院1#实验楼幢) 邮编: 402260 | (+86-23) 863676001 | sgs.china@sgs.com

CH2301	No. 29 of wall A	WA-29
CH2302	No. 30 of wall A	WA-30
CH2303	No. 31 of wall A	WA-31
CH2304	No. 32 of wall A	WA-32
CH2305	No. 33 of wall A	WA-33
CH2306	No. 34 of wall A	WA-34
CH2307	No. 35 of wall A	WA-35
CH2401	No. 36 of wall A	WA-36
CH2402	No. 37 of wall A	WA-37
CH2403	No. 38 of wall A	WA-38
CH2404	No. 39 of wall A	WA-39
CH2405	No. 40 of wall A	WA-40
CH2406	No. 41 of wall A	WA-41
CH2407	No. 42 of wall A	WA-42
CH2408	No. 43 of wall A	WA-43
CH3004	Bottom surface of module 1 in unit A	TA1
CH3005	Bottom surface of module 2 in unit A	TA2
CH3006	Bottom surface of module 3 in unit A	TA3
CH3007	Top surface of module 4 in unit A	TA4
CH3008	Left surface of module 4 in unit A	TA5
CH3009	Right surface of module 4 in unit A	TA6
CH3101	Rear surface of module 4 in unit A	TA7
CH3102	Bottom surface of module 4 in unit A	TA8
CH3103	Top surface of module 5 in unit A	TA9
CH3104	Top surface of module 6 in unit A	TA10
CH3105	Top surface of module 7 in unit A	TA11
CH3106	Top surface of module 8 in unit A	TA12
CH3304	Rear surface of module 1 in unit B	TB1
CH3206	Rear surface of module 2 in unit B	TB2
CH3207	Rear surface of module 3 in unit B	TB3
CH3208	Rear surface of module 4 in unit B	TB4
CH3209	Rear surface of module 5 in unit B	TB5



Unless otherwise agreed in writing, this document is issued by the Company subject to its General Conditions of Service printed overleaf, available on request or accessible at <https://www.sgs.com/en/Terms-and-Conditions>. Attention is drawn to the limitation of liability, indemnification and jurisdiction issues defined therein. Any holder of this document is advised that information contained herein reflects the Company's findings at the time of its intervention only and within the limits of Client's instructions, if any. The Company's sole responsibility is to its Client and this document does not exonerate parties to a transaction from exercising all their rights and obligations under the transaction documents. This document cannot be reproduced except in full, without prior written approval of the Company. Any unauthorized alteration, forgery or falsification of the content or appearance of this document is unlawful and offenders may be prosecuted to the fullest extent of the law. Unless otherwise stated the results shown in this test report refer only to the sample(s) tested and such sample(s) are retained for 30 days only.

Attention: To check the authenticity of testing/inspection report & certificate, please contact us at telephone: (86-755) 8307 1443, or email: CN.Doccheck@sgs.com

Affiliate No.5, No.2 Fajun Road, Shuanglu Street, Jiating District, Chongqing, China (No.1 Laboratory Building, Chongqing Energy College) 402260 | (86-23) 863676001 | www.sgs.com
 中国·重庆市江津区双福街道福云大道2号附6号(重庆能源职业学院1#实验楼幢) 邮编: 402260 | (86-23) 863676001 | sgs.china@sgs.com

CH3210	Rear surface of module 6 in unit B	TB6
CH3301	Rear surface of module 7 in unit B	TB7
CH3302	Rear surface of module 8 in unit B	TB8
CH3107	Right surface of module 1 in unit C	TC1
CH3108	Right surface of module 2 in unit C	TC2
CH3109	Right surface of module 3 in unit C	TC3
CH3110	Right surface of module 4 in unit C	TC4
CH3201	Right surface of module 5 in unit C	TC5
CH3202	Right surface of module 6 in unit C	TC6
CH3203	Right surface of module 7 in unit C	TC7
CH3204	Right surface of module 8 in unit C	TC8
CH1-2-15	Ambient	--
Thermocouple information: Type K, 24AWG.		

P
Y
E



Unless otherwise agreed in writing, this document is issued by the Company subject to its General Conditions of Service printed overleaf, available on request or accessible at <https://www.sgs.com/en/Terms-and-Conditions>. Attention is drawn to the limitation of liability, indemnification and jurisdiction issues defined therein. Any holder of this document is advised that information contained hereon reflects the Company's findings at the time of its intervention only and within the limits of Client's instructions, if any. The Company's sole responsibility is to its Client and this document does not exonerate parties to a transaction from exercising all their rights and obligations under the transaction documents. This document cannot be reproduced except in full, without prior written approval of the Company. Any unauthorized alteration, forgery or falsification of the content or appearance of this document is unlawful and offenders may be prosecuted to the fullest extent of the law. Unless otherwise stated the results shown in this test report refer only to the sample(s) tested and such sample(s) are retained for 30 days only.

Attention: To check the authenticity of testing / inspection report & certificate, please contact us at telephone: (86-755) 8307 1443, or email: CN.Doccheck@sgs.com

SGS-CEC (Chongqing) Technology (Chongqing) Co., Ltd. | Affiliates No.5, No.2 Fuyun Road, Shuanglu Street, Jiating District, Chongqing, China (No.1 Laboratory Building, Chongqing Energy College) 402260 | (86-23) 863676001 | www.sgsgroup.com.cn
 中国·重庆市江津区双福街道福云大道2号附6号(重庆能源职业学院1#实验楼) 邮编: 402280 | (86-23) 863676001 | sgs.china@sgs.com

[Description of test results]

Table 7: Overview of test timeline and key events

Time (HH: MM: SS)	Relative Time (HH: MM: SS)	Event ID	Event	Description	Photo Reference
14:42:00	0:00:00	E1	Test Start	--	Figure 12
14:42:30	0:00:30	E2	Heater 1 and Heater 2 Energized	--	--
15:28:26	0:46:26	E3	Release	Smoke release observed from initiating battery system enclosure.	Figure 13
16:15:01	1:33:01	E4	Release	Smoke release observed from initiating battery system enclosure.	Figure 14
18:42:00	4:00:00	E5	Test Termination	--	--

Chemical heat release rate versus time
Description: No flaming extension observed outside the initiating unit.
N/A

Convective heat release rate (HRRc) versus time
Description: N/A

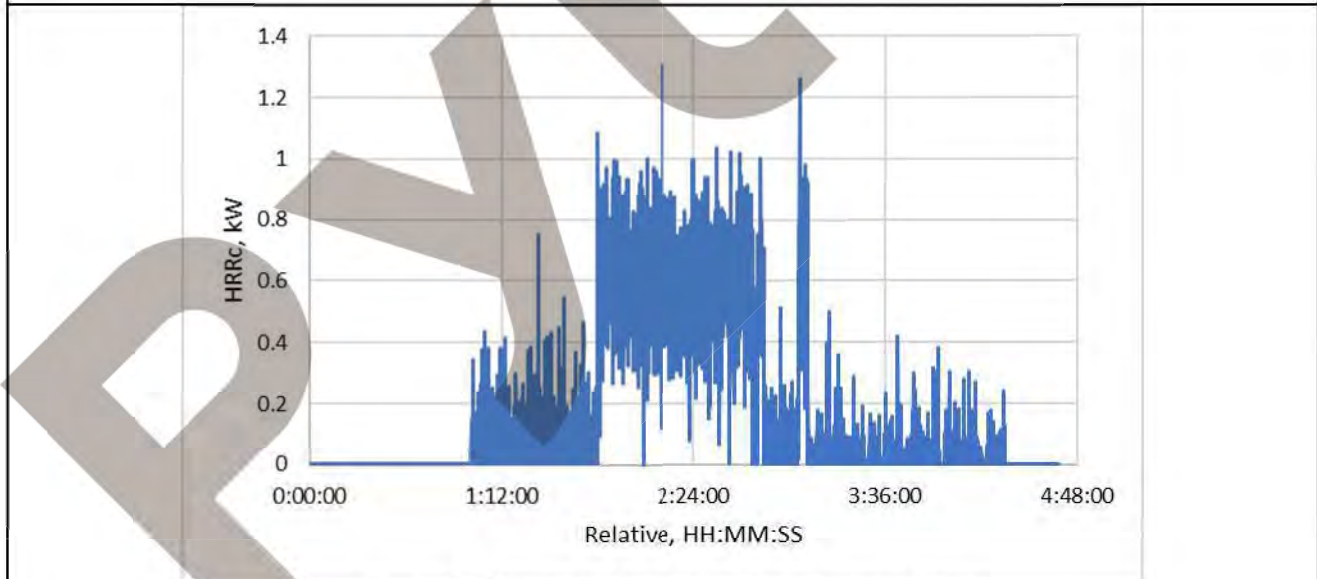

Figure 8. Convective heat release rate versus time



Unless otherwise agreed in writing, this document is issued by the Company subject to its General Conditions of Service printed overleaf, available on request or accessible at <https://www.sgs.com/en/Terms-and-Conditions>. Attention is drawn to the limitation of liability, indemnification and jurisdiction issues defined therein. Any holder of this document is advised that information contained hereon reflects the Company's findings at the time of its intervention only and within the limits of Client's instructions, if any. The Company's sole responsibility is to its Client and this document does not exonerate parties to a transaction from exercising all their rights and obligations under the transaction documents. This document cannot be reproduced except in full, without prior written approval of the Company. Any unauthorized alteration, forgery or falsification of the content or appearance of this document is unlawful and offenders may be prosecuted to the fullest extent of the law. Unless otherwise stated the results shown in this test report refer only to the sample(s) tested and such sample(s) are retained for 30 days only.

Attention: To check the authenticity of testing / inspection report & certificate, please contact us at telephone: (86-755) 8307 1443, or email: CN.Doccheck@sgs.com
 Affiliate No.5, No.2 Fuyun Road, Shuanglu Street, Jiating District, Chongqing, China (No.1 Laboratory Building, Chongqing Energy College) 402260 | (86-23) 863676001 | www.sgsgroup.com.cn
 中国·重庆市江津区双福街道福云大道2号附6号(重庆能源职业学院1#实验楼) 邮编: 402280 | (86-23) 863676001 | sgs.china@sgs.com

Maximum incident heat flux on target units and wall surfaces

Result:

Heat Flux Sensor ID	Description of location
CH1301	Surface of wall A, facing the center of front surface of module 4 in initiating unit
CH1302	Surface of wall A, facing the center of front surface of module 5 in initiating unit
CH1303	Surface of wall B, facing the center of right surface of module 4 in initiating unit
CH1304	Surface of wall B, facing the center of right surface of module 5 in initiating unit
CH1305	Center of rear surface of module 4 in target unit 1(Unit B)
CH1306	Center of rihgt surface of module 4 in target unit 2(Unit C)

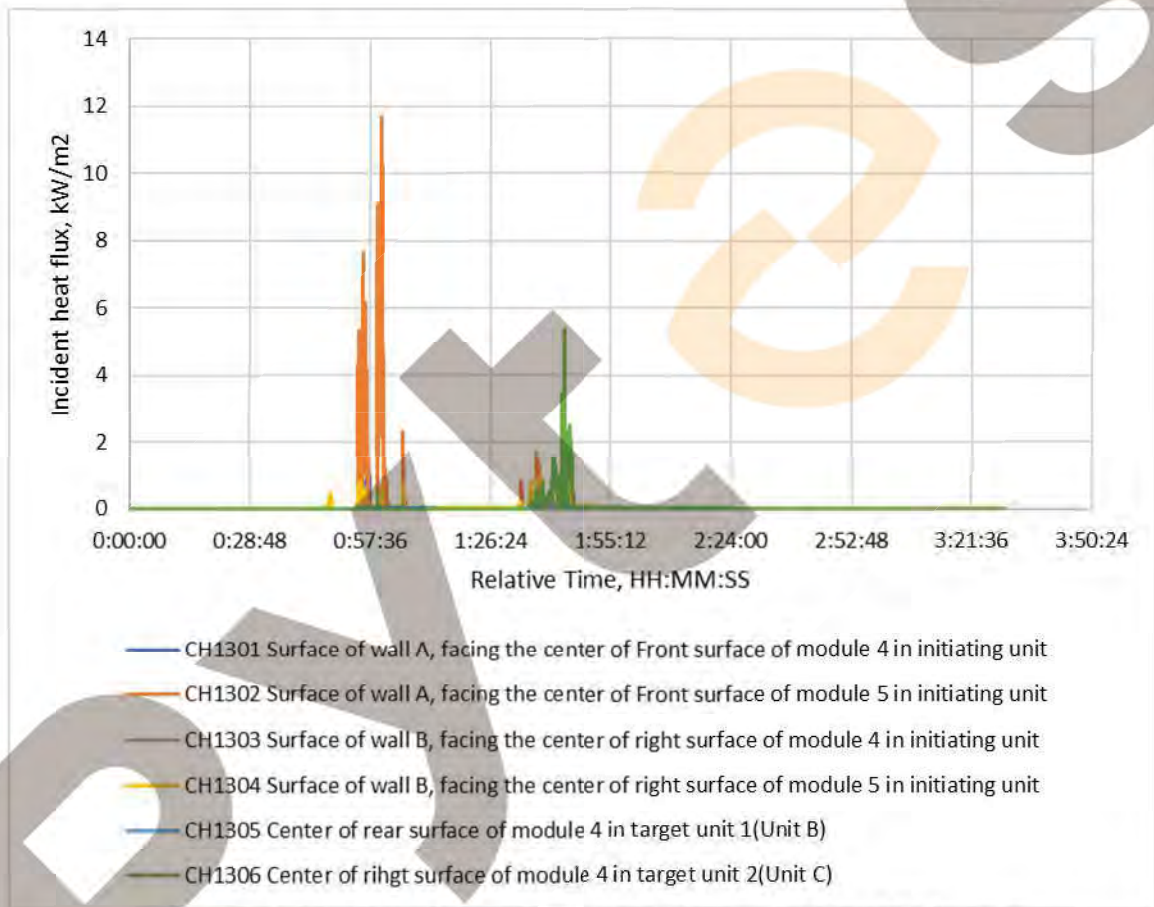

Figure 9. Incident heat flux on target wall surfaces and target BESS units.



Unless otherwise agreed in writing, this document is issued by the Company subject to its General Conditions of Service printed overleaf, available on request or accessible at <https://www.sgs.com/en/Terms-and-Conditions>. Attention is drawn to the limitation of liability, indemnification and jurisdiction issues defined therein. Any holder of this document is advised that information contained hereon reflects the Company's findings at the time of its intervention only and within the limits of Client's instructions, if any. The Company's sole responsibility is to its Client and this document does not exonerate parties to a transaction from exercising all their rights and obligations under the transaction documents. This document cannot be reproduced except in full, without prior written approval of the Company. Any unauthorized alteration, forgery or falsification of the content or appearance of this document is unlawful and offenders may be prosecuted to the fullest extent of the law. Unless otherwise stated the results shown in this test report refer only to the sample(s) tested and such sample(s) are retained for 30 days only.

Attention: To check the authenticity of testing /inspection report & certificate, please contact us at telephone: (86-755) 8307 1443, or email: CN.Doccheck@sgs.com

Affiliate No.5, No.2 Fajun Road, Shuanglu Street, Jiating District, Chongqing, China (No.1 Laboratory Building, Chongqing Energy College) 402260 | (86-23) 863676001 | www.sgsgroup.com.cn
 中国·重庆市江津区双福街道福云大道2号附6号(重庆能源职业学院1#实验楼) 邮编: 402280 | (86-23) 863676001 | sgs.china@sgs.com

Peak smoke release rate and total smoke release

Result:

1. Peak smoke release rate is 1.340 m²/s during test.
2. Total smoke release is 1181 m² during test.

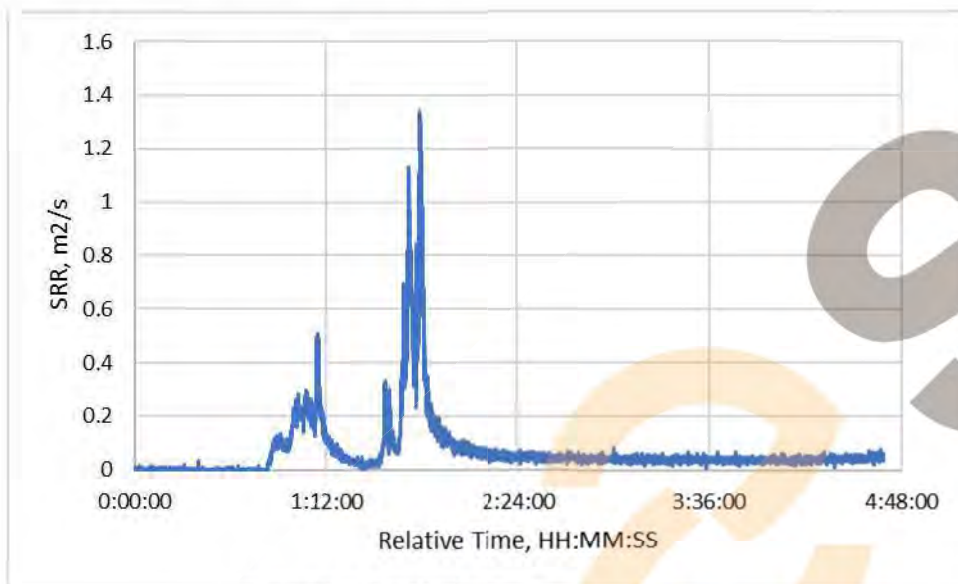

Figure 10. Smoke release rate versus time.



Unless otherwise agreed in writing, this document is issued by the Company subject to its General Conditions of Service printed overleaf, available on request or accessible at <https://www.sgs.com/en/Terms-and-Conditions>. Attention is drawn to the limitation of liability, indemnification and jurisdiction issues defined therein. Any holder of this document is advised that information contained hereon reflects the Company's findings at the time of its intervention only and within the limits of Client's instructions, if any. The Company's sole responsibility is to its Client and this document does not exonerate parties to a transaction from exercising all their rights and obligations under the transaction documents. This document cannot be reproduced except in full, without prior written approval of the Company. Any unauthorized alteration, forgery or falsification of the content or appearance of this document is unlawful and offenders may be prosecuted to the fullest extent of the law. Unless otherwise stated the results shown in this test report refer only to the sample(s) tested and such sample(s) are retained for 30 days only.

Attention: To check the authenticity of testing / inspection report & certificate, please contact us at telephone: (86-755) 8307 1443, or email: CN.Doccheck@sgs.com

SGS-CEC (Chongqing Energy College) Technology (Chongqing) Co., Ltd.

Affiliate No.5, No.2 Fuyun Road, Shuanglu Street, Jiating District, Chongqing, China (No.1 Laboratory Building, Chongqing Energy College) 402260 | (86-23) 863676001 | www.sgsgroup.com.cn
 中国·重庆市江津区双福街道福云大道2号附6号(重庆能源职业学院1#实验楼幢) 邮编: 402280 | (86-23) 863676001 | sgs.china@sgs.com

Flammable gas generation and composition

Flammable gas generation: YES NO

Flammable gas content \geq 25% of LFL or not: N/A.

Description :

Total gas generation during test: 1769 L (25°C, 101kPa)

Recommend smallest room for installation: \geq 142 m³

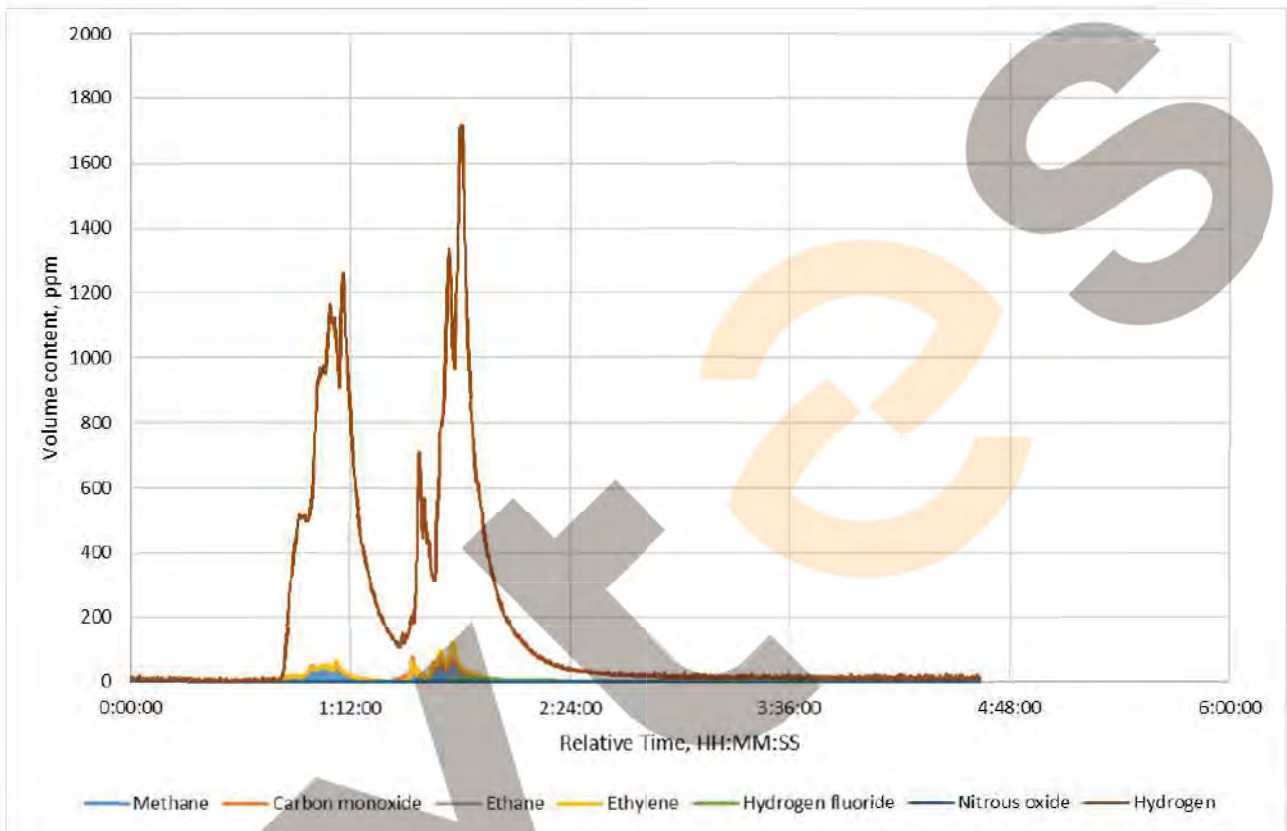

Figure 11. Online flammable gas content measurements during test. (Remark: The content of other hydrocarbons is below the detection limit of the test equipment.)



Unless otherwise agreed in writing, this document is issued by the Company subject to its General Conditions of Service printed overleaf, available on request or accessible at <https://www.sgs.com/en/Terms-and-Conditions>. Attention is drawn to the limitation of liability, indemnification and jurisdiction issues defined therein. Any holder of this document is advised that information contained hereon reflects the Company's findings at the time of its intervention only and within the limits of Client's instructions, if any. The Company's sole responsibility is to its Client and this document does not exonerate parties to a transaction from exercising all their rights and obligations under the transaction documents. This document cannot be reproduced except in full, without prior written approval of the Company. Any unauthorized alteration, forgery or falsification of the content or appearance of this document is unlawful and offenders may be prosecuted to the fullest extent of the law. Unless otherwise stated the results shown in this test report refer only to the sample(s) tested and such sample(s) are retained for 30 days only.

Attention: To check the authenticity of testing / inspection report & certificate, please contact us at telephone: (86-755) 8307 1443, or email: CN.Doccheck@sgs.com

Affiliate No.5, No.2 Fajun Road, Shuangliu Street, Jiating District, Chongqing, China (No.1 Laboratory Building, Chongqing Energy College) 402260 | (86-23) 863676001 | www.sgs.com
 中国·重庆市江津区双福街道福云大道2号附6号(重庆能源职业学院1#实验楼) 邮编: 402280 | (86-23) 863676001 | sgs.china@sgs.com

Locations and visual estimations of flame extension and duration from the unit
Flame extension : <input type="checkbox"/> YES <input checked="" type="checkbox"/> NO
Description : No external flaming observed.
N/A

Table 9: Data during test

Module ID	OCV of Battery Module Before Test, (V dc)	OCV of Battery Module After Test, (V dc)	Observation Results
Module 1 of initiati unit	53.315	53.315	No gas venting observed. No external flaming observed.
Module 2 of initiati unit	53.315	53.315	No gas venting observed. No external flaming observed.
Module 3 of initiati unit	53.320	53.315	No gas venting observed. No external flaming observed.
Module 4 of initiati unit	53.320	0	Gas and smoke venting observed. No external flaming observed. No flying debris observed. No explosion observed.
Module 5 of initiati unit	53.320	53.315	No gas venting observed. No external flaming observed.
Module 6 of initiati unit	53.320	53.320	No gas venting observed. No external flaming observed.
Module 7 of initiati unit	53.320	53.320	No gas venting observed. No external flaming observed.
Module 8 of initiati unit	53.320	53.320	No gas venting observed. No external flaming observed.
Measured Maximum Temperature Rise of Wall Surface			
Thermocouple ID	CH2304		
Measurements, (°C)	122.9 (temperature rise 94.3 °C)		
Location	Surface of wall A		
Limits: $\Delta T \leq 97\text{ °C}$			
Measured Maximum Surface Temperature of Modules within the Target BESS Units			
Thermocouple ID	CH3208		
Measurements, (°C)	158.1		
Location	Rear surface of module 4 in unit B		
Limits: Tmax. $\leq 209.4\text{ °C}$			
Cheesecloth indicator used or not <input checked="" type="checkbox"/> Yes <input type="checkbox"/> No			
Description of cheesecloth indicator after test: No flaming or carbonizing of the cheesecloth indicator.			
Supplementary information: N/A			



Unless otherwise agreed in writing, this document is issued by the Company subject to its General Conditions of Service printed overleaf, available on request or accessible at <https://www.sgs.com/en/Terms-and-Conditions>. Attention is drawn to the limitation of liability, indemnification and jurisdiction issues defined therein. Any holder of this document is advised that information contained hereon reflects the Company's findings at the time of its intervention only and within the limits of Client's instructions, if any. The Company's sole responsibility is to its Client and this document does not exonerate parties to a transaction from exercising all their rights and obligations under the transaction documents. This document cannot be reproduced except in full, without prior written approval of the Company. Any unauthorized alteration, forgery or falsification of the content or appearance of this document is unlawful and offenders may be prosecuted to the fullest extent of the law. Unless otherwise stated the results shown in this test report refer only to the sample(s) tested and such sample(s) are retained for 30 days only.

Attention: To check the authenticity of testing/inspection report & certificate, please contact us at telephone: (86-755) 8307 1443, or email: CN.Doccheck@sgs.com
 Affiliate No.5, No.2 Fuyun Road, Shuanglu Street, Jiating District, Chongqing, China (No.1 Laboratory Building, Chongqing Energy College) 402260 | (86-23) 863676001 | www.sgs.com
 中国·重庆市江津区双福街道福云大道2号附6号(重庆能源职业学院1#实验楼) 邮编: 402280 | (86-23) 863676001 | sgs.china@sgs.com



Figure 12. Photo 01 of initiating BESS unit and target BESS units during test.



Figure 13. Photo 02 of initiating BESS unit and target BESS units during test.



Unless otherwise agreed in writing, this document is issued by the Company subject to its General Conditions of Service printed overleaf, available on request or accessible at <https://www.sgs.com/en/Terms-and-Conditions>. Attention is drawn to the limitation of liability, indemnification and jurisdiction issues defined therein. Any holder of this document is advised that information contained hereon reflects the Company's findings at the time of its intervention only and within the limits of Client's instructions, if any. The Company's sole responsibility is to its Client and this document does not exonerate parties to a transaction from exercising all their rights and obligations under the transaction documents. This document cannot be reproduced except in full, without prior written approval of the Company. Any unauthorized alteration, forgery or falsification of the content or appearance of this document is unlawful and offenders may be prosecuted to the fullest extent of the law. Unless otherwise stated the results shown in this test report refer only to the sample(s) tested and such sample(s) are retained for 30 days only.

Attention: To check the authenticity of testing / inspection report & certificate, please contact us at telephone: (86-755) 8307 1443, or email: CN.Doccheck@sgs.com

SGS-CEC (Chongqing) Technology (Chongqing) Co., Ltd

Affiliate No.5, No.2 Fuyun Road, Shuangshi Street, Jiating District, Chongqing, China (No.1 Laboratory Building, Chongqing Energy College) 402260 t (86-23) 863676001 www.sgs.com
 中国·重庆市江津区双福街道福云大道2号附6号(重庆能源职业学院1#实验楼) 邮编: 402280 t (86-23) 863676001 sgs.china@sgs.com

2022年08月09日 星期二 16:15:01



Figure 14. Photo 03 of initiating BESS unit and target BESS units during test.

PRYTC



Unless otherwise agreed in writing, this document is issued by the Company subject to its General Conditions of Service printed overleaf, available on request or accessible at <https://www.sgs.com/en/Terms-and-Conditions>. Attention is drawn to the limitation of liability, Indemnification and jurisdiction issues defined therein. Any holder of this document is advised that information contained hereon reflects the Company's findings at the time of its intervention only and within the limits of Client's instructions, if any. The Company's sole responsibility is to its Client and this document does not exonerate parties to a transaction from exercising all their rights and obligations under the transaction documents. This document cannot be reproduced except in full, without prior written approval of the Company. Any unauthorized alteration, forgery or falsification of the content or appearance of this document is unlawful and offenders may be prosecuted to the fullest extent of the law. Unless otherwise stated the results shown in this test report refer only to the sample(s) tested and such sample(s) are retained for 30 days only.

Attention: To check the authenticity of testing / inspection report & certificate, please contact us at telephone: (86-755) 8307 1443, or email: CN.Doccheck@sgs.com

SGS-CEC (Chongqing) Technology (Chongqing) Co., Ltd.

Affiliate No.5, No.2 Fajun Road, Shuanglu Street, Jiating District, Chongqing, China (No.1 Laboratory Building, Chongqing Energy College) 402260 T (86-23) 863676001 www.sgsgroup.com.cn
 中国·重庆市江津区双福街道福云大道2号附6号(重庆能源职业学院1#实验楼幢) 邮编: 402280 T (86-23) 863676001 sgs.china@sgs.com



Figure 15. Photo 01 of initiating BESS unit and target BESS units after test.



Figure 16. Photo 02 of initiating BESS unit and target BESS units after test.



Unless otherwise agreed in writing, this document is issued by the Company subject to its General Conditions of Service printed overleaf, available on request or accessible at <https://www.sgs.com/en/Terms-and-Conditions>. Attention is drawn to the limitation of liability, indemnification and jurisdiction issues defined therein. Any holder of this document is advised that information contained hereon reflects the Company's findings at the time of its intervention only and within the limits of Client's instructions, if any. The Company's sole responsibility is to its Client and this document does not exonerate parties to a transaction from exercising all their rights and obligations under the transaction documents. This document cannot be reproduced except in full, without prior written approval of the Company. Any unauthorized alteration, forgery or falsification of the content or appearance of this document is unlawful and offenders may be prosecuted to the fullest extent of the law. Unless otherwise stated the results shown in this test report refer only to the sample(s) tested and such sample(s) are retained for 30 days only.

Attention: To check the authenticity of testing /inspection report & certificate, please contact us at telephone: (86-755) 8307 1443, or email: CN.Doccheck@sgs.com

SGS-CEC (Chongqing Energy College) Technology Co., Ltd.

Affiliate No.5, No.2 Fajun Road, Shuanglu Street, Jiating District, Chongqing, China (No.1 Laboratory Building, Chongqing Energy College) 402260 t (86-23) 863676001 www.sgs.com
 中国·重庆市江津区双福街道福云大道2号附6号(重庆能源职业学院1#实验楼) 邮编: 402260 t (86-23) 863676001 sgs.china@sgs.com

Member of the SGS Group (SGS SA)



Figure 17. Photo 03 of initiating BESS unit and target BESS units after test.

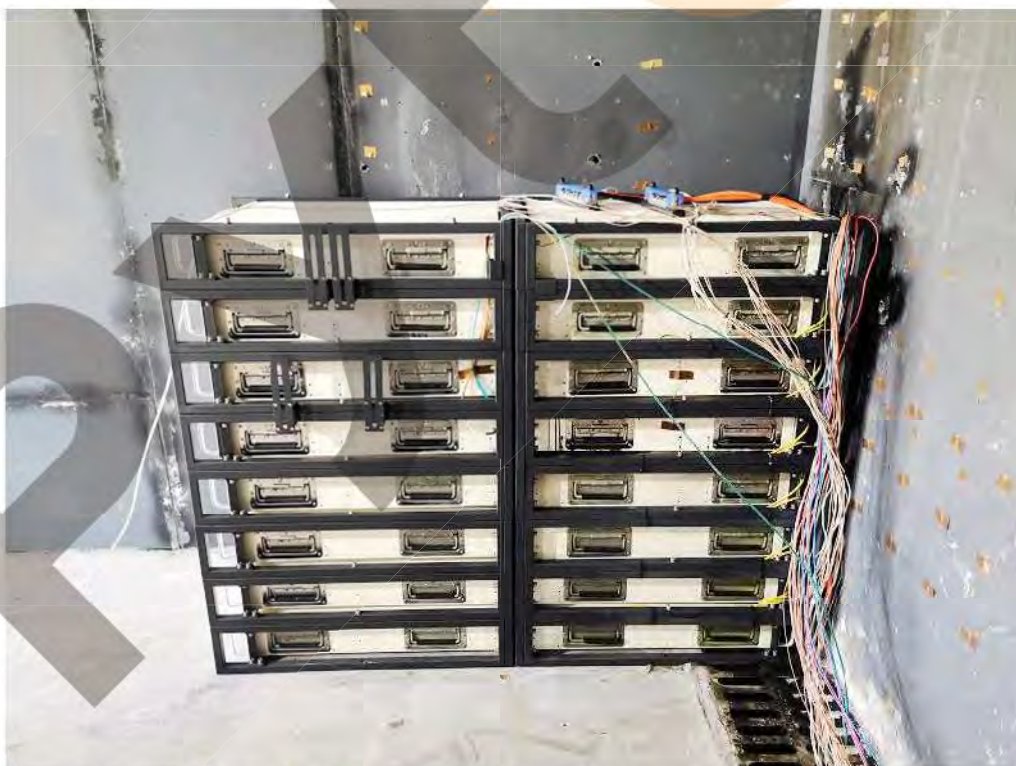

Figure 18. Photo 04 of initiating BESS unit and target BESS units after test.



Unless otherwise agreed in writing, this document is issued by the Company subject to its General Conditions of Service printed overleaf, available on request or accessible at <https://www.sgs.com/en/Terms-and-Conditions>. Attention is drawn to the limitation of liability, indemnification and jurisdiction issues defined therein. Any holder of this document is advised that information contained hereon reflects the Company's findings at the time of its intervention only and within the limits of Client's instructions, if any. The Company's sole responsibility is to its Client and this document does not exonerate parties to a transaction from exercising all their rights and obligations under the transaction documents. This document cannot be reproduced except in full, without prior written approval of the Company. Any unauthorized alteration, forgery or falsification of the content or appearance of this document is unlawful and offenders may be prosecuted to the fullest extent of the law. Unless otherwise stated the results shown in this test report refer only to the sample(s) tested and such sample(s) are retained for 30 days only.

Attention: To check the authenticity of testing /inspection report & certificate, please contact us at telephone: (86-755) 8307 1443, or email: CN.Doccheck@sgs.com

SGS-CEC (Chongqing) Technology Co., Ltd.

Affiliate No.5, No.2 Fuyun Road, Shuanglu Street, Jiating District, Chongqing, China (No.1 Laboratory Building, Chongqing Energy College) 402260 t (86-23) 863676001 www.sgsgroup.com.cn
 中国·重庆市江津区双福街道福云大道2号附6号(重庆能源职业学院1#实验楼) 邮编: 402280 t (86-23) 863676001 sgs.china@sgs.com



Figure 19. Photo 01 of initiating BESS unit after test.



Unless otherwise agreed in writing, this document is issued by the Company subject to its General Conditions of Service printed overleaf, available on request or accessible at <https://www.sgs.com/en/Terms-and-Conditions>. Attention is drawn to the limitation of liability, indemnification and jurisdiction issues defined therein. Any holder of this document is advised that information contained hereon reflects the Company's findings at the time of its intervention only and within the limits of Client's instructions, if any. The Company's sole responsibility is to its Client and this document does not exonerate parties to a transaction from exercising all their rights and obligations under the transaction documents. This document cannot be reproduced except in full, without prior written approval of the Company. Any unauthorized alteration, forgery or falsification of the content or appearance of this document is unlawful and offenders may be prosecuted to the fullest extent of the law. Unless otherwise stated the results shown in this test report refer only to the sample(s) tested and such sample(s) are retained for 30 days only.

Attention: To check the authenticity of testing / inspection report & certificate, please contact us at telephone: (86-755) 8307 1443, or email: CN.Doccheck@sgs.com

SGS-CEC (Chongqing) Technology Co., Ltd.

Affiliate No.5, No.2 Fuyun Road, Shuanglu Street, Jiating District, Chongqing, China (No.1 Laboratory Building, Chongqing Energy College) 402260 t (86-23) 863676001 www.sgsgroup.com.cn
 中国·重庆市江津区双福街道福云大道2号附6号(重庆能源职业学院1#实验楼) 邮编: 402260 t (86-23) 863676001 sgs.china@sgs.com



Figure 20. Photo 02 of initiating BESS unit after test.



Unless otherwise agreed in writing, this document is issued by the Company subject to its General Conditions of Service printed overleaf, available on request or accessible at <https://www.sgs.com/en/Terms-and-Conditions>. Attention is drawn to the limitation of liability, indemnification and jurisdiction issues defined therein. Any holder of this document is advised that information contained hereon reflects the Company's findings at the time of its intervention only and within the limits of Client's instructions, if any. The Company's sole responsibility is to its Client and this document does not exonerate parties to a transaction from exercising all their rights and obligations under the transaction documents. This document cannot be reproduced except in full, without prior written approval of the Company. Any unauthorized alteration, forgery or falsification of the content or appearance of this document is unlawful and offenders may be prosecuted to the fullest extent of the law. Unless otherwise stated the results shown in this test report refer only to the sample(s) tested and such sample(s) are retained for 30 days only.

Attention: To check the authenticity of testing /inspection report & certificate, please contact us at telephone: (86-755) 8307 1443, or email: CN.Doccheck@sgs.com

SGS-CEC (Chongqing) Technology Co., Ltd.

Affiliate No.5, No.2 Fuyun Road, Shuanglu Street, Jiating District, Chongqing, China (No.1 Laboratory Building, Chongqing Energy College) 402260 | (86-23) 863676001 | www.sgsgroup.com.cn
 中国·重庆市江津区双福街道福云大道2号附6号(重庆能源职业学院1#实验楼) 邮编: 402280 | (86-23) 863676001 | sgs.china@sgs.com



Figure 21a. Photo of initiating battery module after test.



Figure 21b. Photo 01 of thermal runaway location.



Figure 21c. Photo 02 of thermal runaway location.



Figure 21d. Photo 03 of thermal runaway location.

PRY



Unless otherwise agreed in writing, this document is issued by the Company subject to its General Conditions of Service printed overleaf, available on request or accessible at <https://www.sgs.com/en/Terms-and-Conditions>. Attention is drawn to the limitation of liability, indemnification and jurisdiction issues defined therein. Any holder of this document is advised that information contained hereon reflects the Company's findings at the time of its intervention only and within the limits of Client's instructions, if any. The Company's sole responsibility is to its Client and this document does not exonerate parties to a transaction from exercising all their rights and obligations under the transaction documents. This document cannot be reproduced except in full, without prior written approval of the Company. Any unauthorized alteration, forgery or falsification of the content or appearance of this document is unlawful and offenders may be prosecuted to the fullest extent of the law. Unless otherwise stated the results shown in this test report refer only to the sample(s) tested and such sample(s) are retained for 30 days only.

Attention: To check the authenticity of testing / inspection report & certificate, please contact us at telephone: (86-755) 8307 1443, or email: CN.Doccheck@sgs.com

Affiliate No.5, No.2 Fuyun Road, Shuanglu Street, Jiating District, Chongqing, China (No.1 Laboratory Building, Chongqing Energy College) 402260 | (86-23) 863676001 | www.sgsgroup.com.cn
 中国·重庆市江津区双福街道福云大道2号附6号(重庆能源职业学院1#实验楼) 邮编: 402280 | (86-23) 863676001 | sgs.china@sgs.com

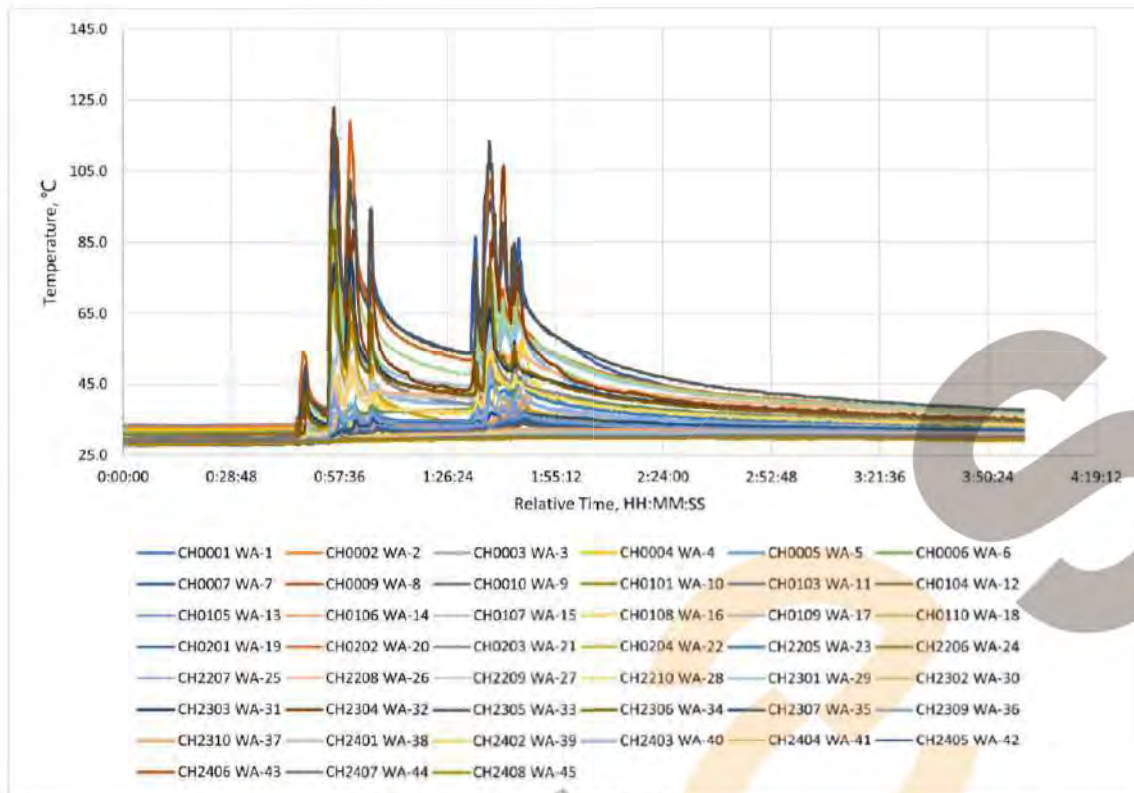

Figure 22. Temperature measurement results on wall A.

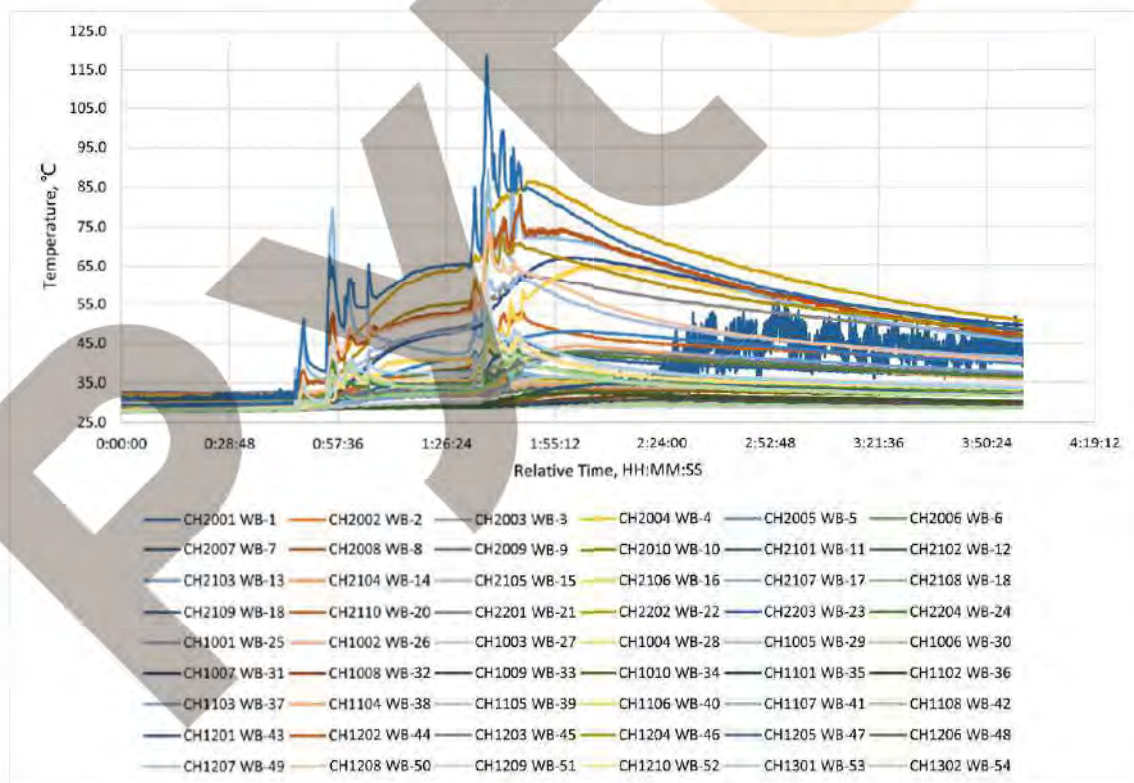

Figure 23. Temperature measurement results on wall B.



Unless otherwise agreed in writing, this document is issued by the Company subject to its General Conditions of Service printed overleaf, available on request or accessible at <https://www.sgs.com/en/Terms-and-Conditions>. Attention is drawn to the limitation of liability, indemnification and jurisdiction issues defined therein. Any holder of this document is advised that information contained hereon reflects the Company's findings at the time of its intervention only and within the limits of Client's instructions, if any. The Company's sole responsibility is to its Client and this document does not exonerate parties to a transaction from exercising all their rights and obligations under the transaction documents. This document cannot be reproduced except in full, without prior written approval of the Company. Any unauthorized alteration, forgery or falsification of the content or appearance of this document is unlawful and offenders may be prosecuted to the fullest extent of the law. Unless otherwise stated the results shown in this test report refer only to the sample(s) tested and such sample(s) are retained for 30 days only.

Attention: To check the authenticity of testing/inspection report & certificate, please contact us at telephone: (+86-755) 8307 1443, or email: CN.Doccheck@sgs.com

Affiliate No.5, No.2 Fajun Road, Shuanglu Street, Jiating District, Chongqing, China (No.1 Laboratory Building, Chongqing Energy College) 402260 t (86-23) 863676001 www.sgs.com
 中国·重庆市江津区双福街道福云大道2号附6号(重庆能源职业学院1#实验楼) 邮编: 402280 t (86-23) 863676001 sgs.china@sgs.com

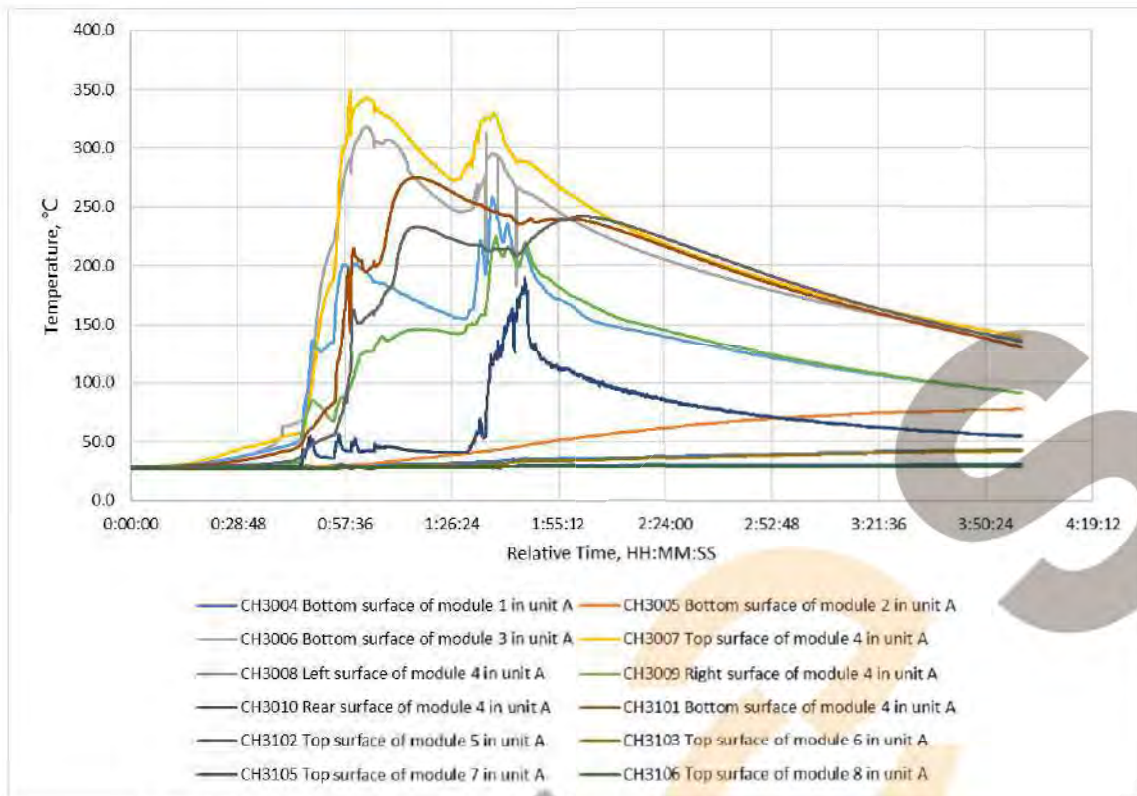

Figure 24. Temperature measurement results on the initiating unit (unit A).

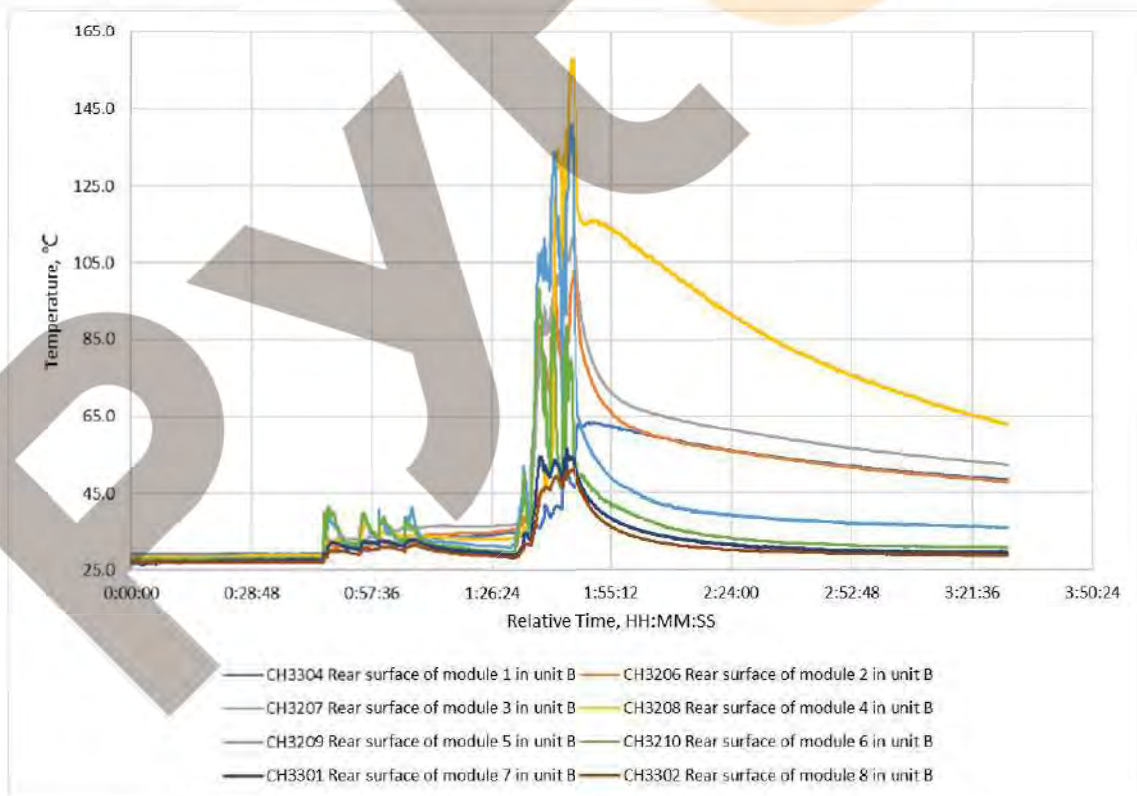

Figure 25. Temperature measurement results on target units (Unit B)



Unless otherwise agreed in writing, this document is issued by the Company subject to its General Conditions of Service printed overleaf, available on request or accessible at <https://www.sgs.com/en/Terms-and-Conditions>. Attention is drawn to the limitation of liability, indemnification and jurisdiction issues defined therein. Any holder of this document is advised that information contained hereon reflects the Company's findings at the time of its intervention only and within the limits of Client's instructions, if any. The Company's sole responsibility is to its Client and this document does not exonerate parties to a transaction from exercising all their rights and obligations under the transaction documents. This document cannot be reproduced except in full, without prior written approval of the Company. Any unauthorized alteration, forgery or falsification of the content or appearance of this document is unlawful and offenders may be prosecuted to the fullest extent of the law. Unless otherwise stated the results shown in this test report refer only to the sample(s) tested and such sample(s) are retained for 30 days only.

Attention: To check the authenticity of testing/inspection report & certificate, please contact us at telephone: (+86-755) 8307 1443, or email: CN.Doccheck@sgs.com
 Affiliate No.5, No.2 Fuyun Road, Shuanglu Street, Jiating District, Chongqing, China (No.1 Laboratory Building, Chongqing Energy College) 402260 | (+86-23) 863676001 | www.sgs.com
 中国·重庆市江津区双福街道福云大道2号附6号(重庆能源职业学院1#实验楼) 邮编: 402280 | (+86-23) 863676001 | sgs.china@sgs.com

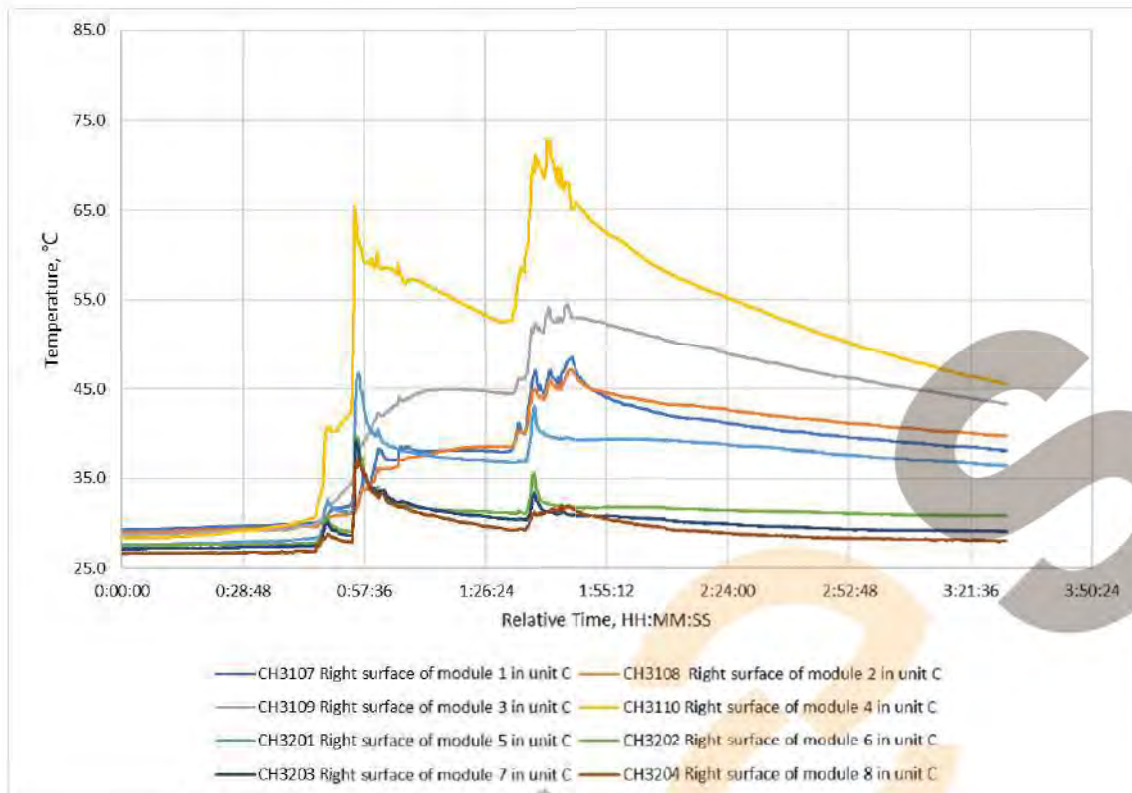

Figure 26. Temperature measurement results on target units (Unit C)

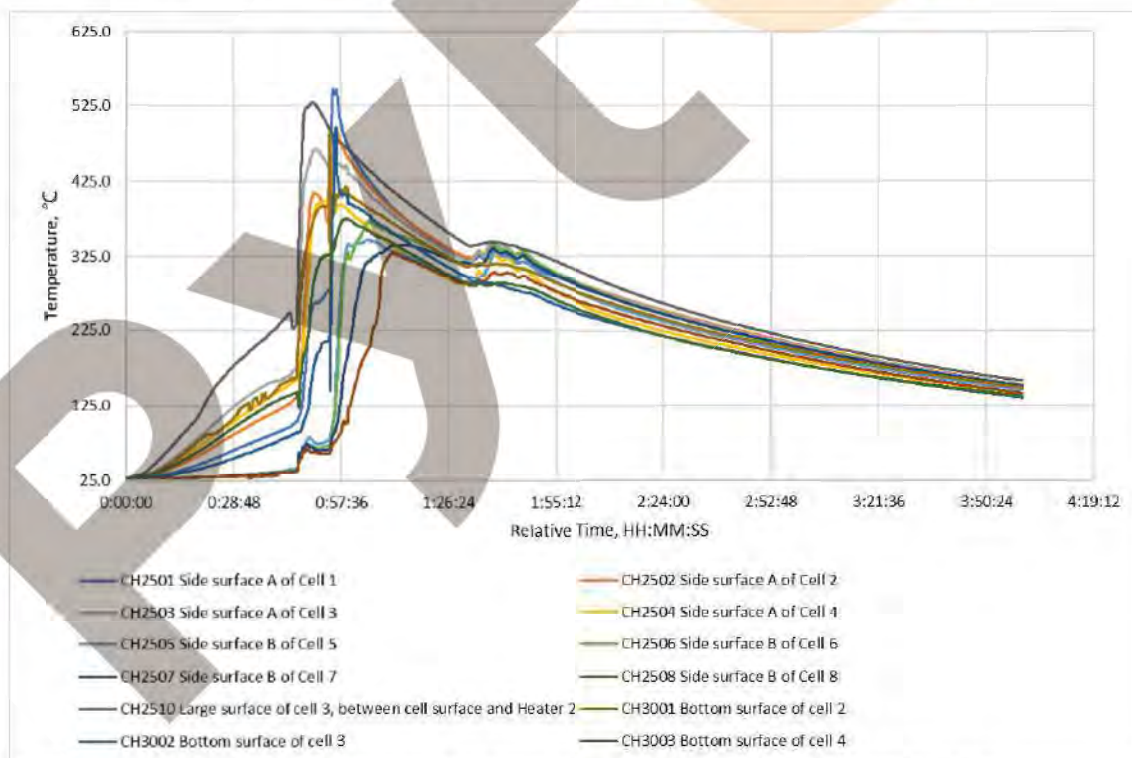

Figure 27. Temperature measurement results on the initiating module.



Unless otherwise agreed in writing, this document is issued by the Company subject to its General Conditions of Service printed overleaf, available on request or accessible at <https://www.sgs.com/en/Terms-and-Conditions>. Attention is drawn to the limitation of liability, indemnification and jurisdiction issues defined therein. Any holder of this document is advised that information contained hereon reflects the Company's findings at the time of its intervention only and within the limits of Client's instructions, if any. The Company's sole responsibility is to its Client and this document does not exonerate parties to a transaction from exercising all their rights and obligations under the transaction documents. This document cannot be reproduced except in full, without prior written approval of the Company. Any unauthorized alteration, forgery or falsification of the content or appearance of this document is unlawful and offenders may be prosecuted to the fullest extent of the law. Unless otherwise stated the results shown in this test report refer only to the sample(s) tested and such sample(s) are retained for 30 days only.

Attention: To check the authenticity of testing/inspection report & certificate, please contact us at telephone: (+86-755) 8307 1443, or email: CN.Doccheck@sgs.com
 Affiliate No.5, No.2 Fuyun Road, Shuangshi Street, Jiating District, Chongqing, China (No.1 Laboratory Building, Chongqing Energy College) 402260 t (+86-23) 863676001 www.sgs.com.cn
 中国·重庆市江津区双福街道福云大道2号附6号(重庆能源职业学院1#实验楼) 邮编: 402280 t (+86-23) 863676001 sgs.china@sgs.com

NOTES TO THIS TEST REPORT

1. Copyright © 2021 SGS-CEC New Energy Technology (Chongqing) Co., Ltd. All rights reserved. This publication may be produced in whole or in part for non-commercial purposes as long as SGS-CEC is acknowledged as copyright owner and source of the material. SGS-CEC takes no responsibility for and will not assume liability for damages resulting from the reader's interpretation of the reproduced material due to its placement and context.
2. According to the standard, instruction sheets and other texts required by the standard should be written in the official language(s) of the country in which the product is to be sold. The applicant should ensure that the product in future production fulfils the receptive standard requirements.
3. The components performed satisfactorily during testing and are considered to be suitable for use in the sample tested.

--- End of Report ---

PLYTE
 SGS



Unless otherwise agreed in writing, this document is issued by the Company subject to its General Conditions of Service printed overleaf, available on request or accessible at <https://www.sgs.com/en/Terms-and-Conditions>. Attention is drawn to the limitation of liability, indemnification and jurisdiction issues defined therein. Any holder of this document is advised that information contained hereon reflects the Company's findings at the time of its intervention only and within the limits of Client's instructions, if any. The Company's sole responsibility is to its Client and this document does not exonerate parties to a transaction from exercising all their rights and obligations under the transaction documents. This document cannot be reproduced except in full, without prior written approval of the Company. Any unauthorized alteration, forgery or falsification of the content or appearance of this document is unlawful and offenders may be prosecuted to the fullest extent of the law. Unless otherwise stated the results shown in this test report refer only to the sample(s) tested and such sample(s) are retained for 30 days only.

Attention: To check the authenticity of testing / inspection report & certificate, please contact us at telephone: (86-755) 8307 1443, or email: CN.Doccheck@sgs.com

SGS-CEC New Energy Technology (Chongqing) Co., Ltd.

Affiliate No.5, No.2 Fajun Road, Shuanglu Street, Jiating District, Chongqing, China (No.1 Laboratory Building, Chongqing Energy College) 402260 | (86-23) 863676001 | www.sgs.com
 中国·重庆市江津区双福街道福云大道2号附6号(重庆能源职业学院1#实验楼) 邮编: 402280 | (86-23) 863676001 | sgs.china@sgs.com